

MODERN CRANE



STINGER 4792 | Boom Truck Crane

BOOM TRUCK CRANE STINGER 4792



FEATURES

- ▶ 47,000 lb (21 319 kg) maximum lifting capacity
- ▶ 101' (30.78 m) maximum sheave height
- ▶ 144' (43.89 m) maximum sheave height with 26-44' (7.92-13.41 m) jib
- ▶ 29-92' (8.84-28.04 m) four-section full power fully synchronized boom
- ▶ Exclusive color coded boom and load charts
- ▶ Easy-to-install optional 26' (7.92 m) one stage or 26-44' (7.92-13.41 m) two stage telescoping jib, man baskets or work platform increase job capacities
- ▶ Electronic Load Moment Indicator and anti-two-block device standard
- ▶ Externally located planetary rotation drive for easy accessibility for maintenance
- ▶ 2-speed planetary winch has 10,500 lb (4 703 kg) maximum permissible 1 part line, 37,000 lb (16 783 kg) breaking strength, 186 ft/min (57 m/min) maximum line speed
- ▶ Dual control station with direct mechanically controlled hydraulic system
- ▶ 90 gal (342 L) capacity hydraulic tank

MODERN CRANE



BOOM TRUCK CRANE STINGER 4792

BT MODEL

LOAD RATINGS



CAUTION Do not use this specification sheet as a load rating chart. The format of data is not consistent with the machine chart and may be subject to change.

BOOM LENGTH Maximum Load Chart in pounds (lbs) with fully extended outrigger

OPERATING RADIUS (FT)	29 FT		44 FT		57 FT		71 FT		84 FT		92 FT	
	LOADED BOOM ANGLE (DEG)	LOAD RATING (LB)	LOADED BOOM ANGLE (DEG)	LOAD RATING (LB)	LOADED BOOM ANGLE (DEG)	LOAD RATING (LB)	LOADED BOOM ANGLE (DEG)	LOAD RATING (LB)	LOADED BOOM ANGLE (DEG)	LOAD RATING (LB)	LOADED BOOM ANGLE (DEG)	LOAD RATING (LB)
5	78	47,000*										
8	71	36,800*	78	20,300*								
10	67	30,900*	75	20,300*	79	18,400*						
12	62	26,100*	73	20,300*	77	17,400*						
14	58	21,900*	70	19,400*	75	16,800*	78	14,600*				
16	53	18,800*	67	17,300*	73	15,900*	77	13,800*	79	12,300*		
20	41	14,200*	61	13,900*	68	13,400*	73	12,300*	76	10,900*	78	9,825*
25	21	10,400*	53	10,900*	63	10,600*	69	10,400*	73	9,800*	75	9,025*
30			45	8,625*	57	8,625*	65	8,425*	69	8,225*	71	7,425*
35			34	6,925*	51	6,925*	60	6,925*	66	6,725*	68	6,325*
40			19	5,225*	44	5,625*	56	5,625*	62	5,625*	65	5,425*
45					36	4,625*	50	4,625*	58	4,625*	61	4,625*
50					26	3,725*	45	3,725*	53	3,725*	57	3,725*
55					1	1,225*	38	3,025*	49	3,025*	53	3,025*
60							31	2,425*	44	2,425*	49	2,425*
65							21	2,025*	39	2,025*	45	2,025*
70									32	1,525*	40	1,525*
75									25	1,225*	35	1,225*
80									14	825*	28	825*

NOTE: STRUCTURAL STRENGTH RATINGS IN CHART ARE INDICATED WITH AN ASTERISK *

AREA OF OPERATION

DO NOT OPERATE IN SHADED AREA WITHOUT OPTIONAL FRONT STABILIZER

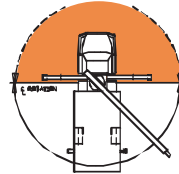

Deductions from rate loads for load handling devices BT

Overhaul Ball	175 lbs
1 Sheave Load Block	200 lbs
2 Sheave Load Block	250 lbs

STOWED JIB DEDUCTIONS (POUNDS)	700	500	350	300	250	200

JIB CAPACITIES FOR ALL BOOM LENGTHS VERIFY OPERATIONAL MODE SETTING ON LMI DISPLAY BEFORE LIFTING WITH JIB

Loaded Boom Angle	50°	55°	60°	65°	70°	75°	78°	80°
Retracted 26 ft Jib	725	1,025	1,525	2,325	3,225	4,325	4,925	5,325
Extended 44 ft Jib	425	725	1,125	1,525	2,025	2,525	2,825	3,125

RANGE DIAGRAM (29 - 92 FT BOOM)

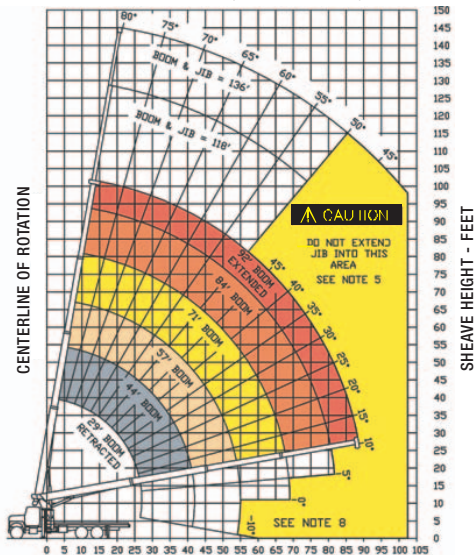

GENERAL NOTES

- The operator must read and understand the Owner's Manual before operating this crane.
- Positioning or operation of crane beyond areas shown on this chart is not intended or approved except where specified in Owner's Manual.
- Loaded boom angles at specified boom lengths give only an approximation of the operating radius. The boom angle before loading should be greater to account for deflections. Do not exceed the operating radius for rated loads.
- Use rating of next longer boom for boom lengths not shown. Use rating of next greater radius for load radii not shown.
- Boom must be fully retracted when jib is erected before lowering below minimum angle. Retracted jib has no lifting capacity below a 50° boom angle.
- Use rating of next lower boom angle for boom angles not shown on jib load rating chart.
- Lifting off the main boom point while the swing around jib is erected is not intended or approved.
- Do not lower boom into this area, as hydraulic pressure will not allow raising the boom without retracting boom first.
- Crane load ratings on outriggers are based on freely suspended loads with the machine leveled and standing on a firm uniform supporting surface. No attempt shall be made to move a load horizontally on the ground in any direction.
- Practical working loads depend on supporting surface, wind and other factors affecting stability such as hazardous surroundings, experience of personnel, and proper handling, must all be taken into account by the operator.
- The maximum load which may be telescoped is limited by hydraulic pressure, boom angle, and boom lubrication. It is safe to attempt to telescope any load within the limits of the load rating chart.

INFORMATION

- Deductions must be made from rated loads for stowed jib, optional attachments, hooks and loadblocks (see deduction chart). Weights of slings and other load handling devices shall be considered a part of the load.
- Crane load ratings with outriggers are based on outriggers and stabilizers extended and set with all load removed from the carrier wheels.
- Load ratings do not exceed 85% of tipping load.

DEFINITIONS

- Operating radius is the horizontal distance from the axis of rotation to the center of the vertical hoist line or load hook with load suspended.
- Loaded boom angle as shown in the Load Ratings Chart is the included angle between the horizontal and longitudinal axes of the boom base after lifting rated load at rated radius.

MODERN CRANE



BOOM TRUCK CRANE STINGER 4792

RM MODEL

LOAD RATINGS CAUTION Do not use this specification sheet as a load rating chart. The format of data is not consistent with the machine chart and may be subject to change.

BOOM LENGTH Maximum Load Chart in pounds (lbs) with fully extended outrigger

OPERATING RADIUS (ft)	29 FT		44 FT		57 FT		71 FT		84 FT		92 FT	
	LOADED BOOM ANGLE (DEG)	LOAD RATING (LB)	LOADED BOOM ANGLE (DEG)	LOAD RATING (LB)	LOADED BOOM ANGLE (DEG)	LOAD RATING (LB)	LOADED BOOM ANGLE (DEG)	LOAD RATING (LB)	LOADED BOOM ANGLE (DEG)	LOAD RATING (LB)	LOADED BOOM ANGLE (DEG)	LOAD RATING (LB)
5	78	17,000*										
8	71	36,800*	78	20,300*								
10	67	30,900*	75	20,300*	79	18,400*						
12	62	26,100*	73	20,300*	77	17,100*						
14	58	21,900*	70	19,400*	75	16,800*	78	14,600*				
16	53	18,800*	67	17,300*	73	15,900*	77	13,800*	79	12,300*		
20	41	14,200*	61	13,900*	68	13,400*	73	12,300*	76	10,900*	78	9,825*
25	21	10,400*	53	10,900*	63	10,600*	68	10,400*	73	9,800*	75	9,025*
30			45	8,625*	57	8,625*	65	8,425*	69	8,225*	71	7,425*
35			34	6,925*	51	6,925*	60	6,925*	66	6,725*	68	6,325*
40			19	5,225*	44	5,625*	56	5,625*	62	5,625*	65	5,425*
45					36	4,625*	50	4,625*	58	4,825*	61	4,625*
50					26	3,725*	45	3,725*	53	3,725*	57	3,725*
55					1	1,225*	38	3,025*	49	3,025*	53	3,025*
60							31	2,425*	44	2,425*	49	2,425*
65							21	2,025*	39	2,025*	45	2,025*
70									32	1,525*	40	1,525*
75									25	1,225*	35	1,225*
80									14	825*	28	825*

NOTE: STRUCTURAL STRENGTH RATINGS IN CHART ARE INDICATED WITH AN ASTERISK *

AREA OF OPERATION
360° Full Capacity Area of Operation

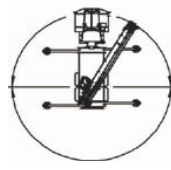

Deductions from rate loads for load handling devices BT

Overhaul Ball	175 lbs
1 Sheave Load Block	200 lbs
2 Sheave Load Block	250 lbs

STOWED JIB DEDUCTIONS (POUNDS)

700	500	350	300	250	200
-----	-----	-----	-----	-----	-----

JIB CAPACITIES FOR ALL BOOM LENGTHS VERIFY OPERATIONAL MODE SETTING ON LMI DISPLAY BEFORE LIFTING WITH JIB

Loaded Boom Angle	50°	55°	60°	65°	70°	75°	78°	80°
Retracted 26ft Jib	725	1,025	1,525	2,325	3,225	4,325	4,925	5,325
Extended 44 ft Jib	425	725	1,125	1,525	2,025	2,525	2,825	3,125

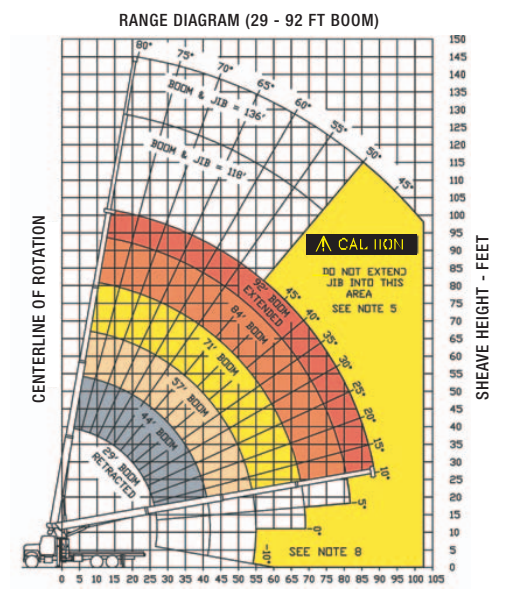

GENERAL NOTES

- The operator must read and understand the Owner's Manual before operating this crane.
- Positioning or operation of crane beyond areas shown on this chart is not intended or approved except where specified in Owner's Manual.
- Loaded boom angles at specified boom lengths give only an approximation of the operating radius. The boom angle before loading should be greater to account for deflections. Do not exceed the operating radius for rated loads.
- Use rating of next longer boom for boom lengths not shown. Use rating of next greater radius for load radii not shown.
- Boom must be fully retracted when jib is erected before lowering below minimum angle. Retracted jib has no lifting capacity below a 50° boom angle.
- Use rating of next lower boom angle for boom angles not shown on jib load rating chart.
- Lifting off the main boom point while the swing around jib is erected is not intended or approved.
- Do not lower boom into this area, as hydraulic pressure will not allow raising the boom without retracting boom first.
- Crane load ratings on outriggers are based on freely suspended loads with the machine leveled and standing on a firm uniform supporting surface. No attempt shall be made to move a load horizontally on the ground in any direction.
- Practical working loads depend on supporting surface, wind and other factors affecting stability such as hazardous surroundings, experience of personnel, and proper handling, must all be taken into account by the operator.
- The maximum load which may be telescoped is limited by hydraulic pressure, boom angle, and boom lubrication. It is safe to attempt to telescope any load within the limits of the load rating chart.

INFORMATION

- Deductions must be made from rated loads for stowed jib, optional attachments, hooks and loadblocks (see deduction chart). Weights of slings and other load handling devices shall be considered a part of the load.
- Crane load ratings with outriggers are based on outriggers and stabilizers extended and set with all load removed from the carrier wheels.
- Load ratings do not exceed 85% of tipping load.

DEFINITIONS

- Operating radius is the horizontal distance from the axis of rotation to the center of the vertical hoist line or load hook with load suspended.
- Loaded boom angle as shown in the Load Ratings Chart is the included angle between the horizontal and longitudinal axes of the boom base after lifting rated load at rated radius.

MODERN CRANE



BOOM TRUCK CRANE STINGER 4792

BT MODEL

WINCH DATA						
		1 Part Line	2 Part Line	3 Part Line	4 Part Line	5 Part Line
Winch	Cable Supplied	Lift and Speed	Lift and Speed	Lift and Speed	Lift and Speed	Lift and Speed
Standard Stationary Winch	9/16" Diam IWRC XXIP	10,500 lb 186 fpm	21,000 lb 93 fpm	31,500 lb 62 fpm	42,000 lb 46 fpm	47,000 lb 37 fpm
	9/16" Diam Rotation Resistant	6,720 lb 186 fpm	13,440 lb 93 fpm	20,100 lb 62 fpm	26,880 lb 46 fpm	33,600 lb 37 fpm

BLOCK TYPE	
Overhaul Ball	Rating: 6.25 ton (5.7 mt)
1 Sheave Block	Rating: 17.5 ton (15.9 mt)
2 Sheave Block	Rating: 22.5 ton (20.4 mt)

CAUTION ⚠️

Overload and anti-two-block systems must be in good operating condition before operating crane. Refer to Owners Manual.

Keep at least 3 wraps of loadline on drum at all times.

Use only 9/16" diameter cable with 37,000 lb breaking strength on this machine.

2 MOUNTING CONFIGURATIONS

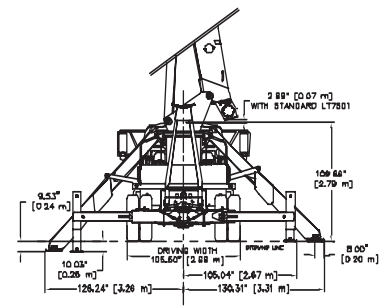
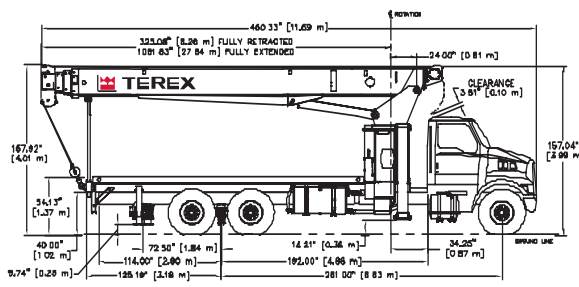

CARRIER PROVIDED BY TEREX

STINGER BT4792 - Behind Cab Mounting Configuration	
▶ Manufacturer	Sterling LT7501 6 x 4 (60 000)
▶ Standard Engine	Caterpillar C-7 7.2 L I-6
▶ Standard Horsepower	300 hp @ 2,200 rpm
▶ Standard Torque	860 lb. Ft. @ 1,440 rpm
▶ Full Tank Capacity	120 gal (454 L)
▶ Standard Transmission	Eaton Fuller RT-8908LL
▶ Speed Standard Transmission	Manual 10-speed
▶ Max Speed Standard Transmission	74 mph (120 km/h)
▶ Max Gradeability	54%
Standard Transmission	
▶ Optional Transmission	Allison
▶ Speed Optional Transmission	Automatic 6-speeds
▶ Max Speed Optional Transmission	74 mph (120 km/h)
▶ Max Gradeability	17%
Optional Transmission	
▶ Gross Vehicle Weight Rating	60,000 lb (27 210 kg)
▶ Front Axle Weight Rating	20,000 lb (9 067 kg)
▶ Rear Axle Weight Rating	40,000 lb (18 144 kg)
▶ Front Tires	425/65R 22.5 Michelin XZY (20 ply)
▶ Rear Tires	11R 22.5 Michelin XDE M/S (14 ply)
▶ Brakes	Air, Hydraulic Anti-Lock System
▶ Exhaust Position	Vertical Right Side

INCLUDED OPTIONS

- ▶ Dual fuel tank (120 gal-454L)
- ▶ Power Steering
- ▶ Electric Horn
- ▶ Factory A/C
- ▶ Power Port (Cigar lighter)
- ▶ AM/FM Radio w/ Clock
- ▶ Dual West Coast Stainless Rear View Mirrors
- ▶ Standard Factory Warranty

CHASSIS RECOMMENDATIONS

STINGER BT4792 - Behind Cab Mounting Configuration	
▶ Combined Axle Weight Rating	60,000 lb (27 210 kg)
▶ Front Axle Weight Rating	20,000 lb (9 067 kg)
▶ Rear Axle Weight Rating	40,000 lb (18 144 kg)
▶ Wheel base	261" (6.62 m)
▶ Cab to Axle	192" (4.87 m)
▶ Afterframe	114" (2.89 m)
▶ Frame Section Modulus	30.0 in ³ (491 cm ³)
▶ RBM per Frame Rail	1,860,000 in/lb (32 950 kg/m)
▶ Frame Height (Unloaded)	40" (7.62 m)
▶ Exhaust Position	Vertical Right Side

MODERN CRANE



BOOM TRUCK CRANE STINGER 4792

RM MODEL

WINCH DATA						
		1 Part Line	2 Part Line	3 Part Line	4 Part Line	5 Part Line
Winch	Cable Supplied	Lift and Speed	Lift and Speed	Lift and Speed	Lift and Speed	Lift and Speed
Standard Stationary Winch	9/16" Diam IWRC XXIP	10,500 lb 186 fpm	21,000 lb 93 fpm	31,500 lb 62 fpm	42,000 lb 46 fpm	47,000 lb 37 fpm
	9/16" Diam Rotation Resistant	6,720 lb 186 fpm	13,440 lb 93 fpm	20,100 lb 62 fpm	26,880 lb 46 fpm	33,600 lb 37 fpm

BLOCK TYPE	
Overhaul Ball	Rating: 6.25 ton (5.7 mt)
1 Sheave Block	Rating: 17.5 ton (15.9 mt)
2 Sheave Block	Rating: 22.5 ton (20.4 mt)

CAUTION ⚠️

Overload and anti-two-block systems must be in good operating condition before operating crane. Refer to Owners Manual. Keep at least 3 wraps of loadline on drum at all times. Use only 9/16" diameter cable with 37,000 lb breaking strength on this machine.

2 MOUNTING CONFIGURATIONS

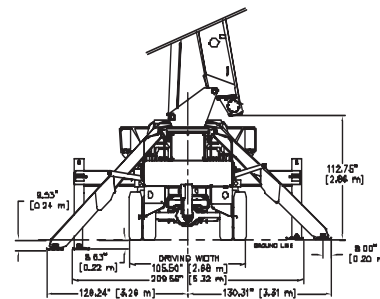
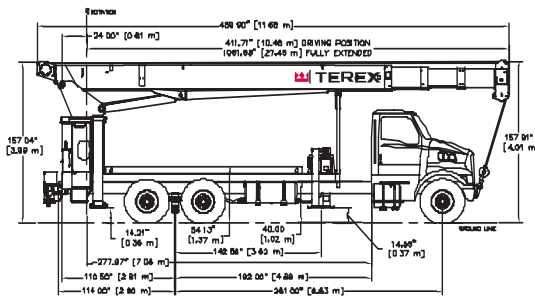

CARRIER PROVIDED BY TEREX	
STINGER RM4792 Rear Mount Configuration	
▶ Manufacturer	Sterling LT7501 6 x 4 (60 000)
▶ Standard Engine	Caterpillar C-7 7.2 L I-6
▶ Standard Horsepower	300 hp @ 2,200 rpm
▶ Standard Torque	860 lb. Ft. @ 1,440 rpm
▶ Full Tank Capacity	120 gal (454 L)
▶ Standard Transmission	Eaton Fuller RT-8908LL
▶ Speed Standard Transmission	Manual 10-speed
▶ Max Speed Standard Transmission	74 mph (120 km/h)
▶ Max Gradeability	54%
Standard Transmission	
▶ Optional Transmission	Allison
▶ Speed Optional Transmission	Automatic 6-speeds
▶ Max Speed Optional Transmission	74 mph (120 km/h)
▶ Max Gradeability	17%
Optional Transmission	
▶ Gross Vehicle Weight Rating	60,000 lb (27 210 kg)
▶ Front Axle Weight Rating	20,000 lb (9067 kg)
▶ Rear Axle Weight Rating	40,000 lb (18 144 kg)
▶ Front Tires	425/65R 22.5 Michelin XZY (20 ply)
▶ Rear Tires	11R 22.5 Michelin XDE M/S (14 ply)
▶ Brakes	Air, Hydraulic Anti-Lock System
▶ Exhaust Position	Vertical Right Side

INCLUDED OPTIONS	
▶ Dual Fuel tanks (120 gal-454L)	
▶ Power steering	
▶ Electric Horn	
▶ Factory A/C	
▶ Power Port (Cigar lighter)	
▶ AM/FM Radio w/ Clock	
▶ Dual West Coast Stainless Rear View Mirrors	
▶ Standard Factory Warranty	

CHASSIS RECOMMENDATIONS	
STINGER RM4792 - Rear Mount Configuration	
▶ Combined Axle Weight Rating	60,000 lb (27 210 kg)
▶ Front Axle Weight Rating	20,000 lb (9 067 kg)
▶ Rear Axle Weight Rating	40,000 lb (18 144 kg)
▶ Wheel base	261" (6.62 m)
▶ Cab to Axle	192" (4.87 m)
▶ Afterframe	114" (2.89 m)
▶ Frame Section Modulus	30.0 in ³ (491 cm ³)
▶ RBM per Frame Rail	1,860,000 in/lb (32 950 kg/m)
▶ Frame Height (Unloaded)	40" (7.62 m)
▶ Exhaust Position	Vertical Right Side

MODERN CRANE



BOOM TRUCK CRANE STINGER 4792

BT MODEL

SPECIFICATIONS

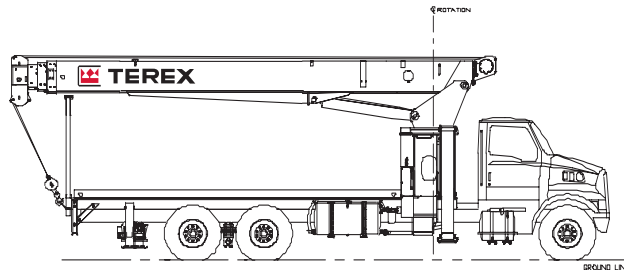

BOOM

- ▶ 29-92' (8.84-28.04 m) four-section full power fully synchronized boom. Patented keel boom design utilizes a keel shaped base plate combined with a deep, four plate boom section to optimize strength / rigidity-to-height ratio. Exclusive, patented color-coded boom and load charts allow the operator to easily determine boom extension, boom angle and load capacity. Maximum sheave height with four-section 29-92' (8.84-28.04 m) boom is 101' (30.78 m). Maximum sheave height with optional two-stage 26-44' (7.92-13.41 m) jib is 144' (43.89 m).

WINCH

- ▶ Hydraulic winch with gear motor and planetary reduction gearing provides 2-speed operation. First layer rope pull is 11,400 lb (5 170 kg). Wire rope size is 9/16" (14 mm) with 37,000 lb (16 783 kg) breaking strength.

OPERATING SPEEDS

- ▶ Mainframe / turret assembly planetary gear rotation provides 180° rotation (370° with optional front bumper outrigger). Swing rotation is 75 seconds. Boom up/down is 41/30 seconds and boom extend/retract is 80/36 seconds.

HYDRAULICS

- ▶ Three-section pump allows the operator to perform simultaneous crane operations (winch, boom and swing). Capacities are 32, 17 and 8 gpm (122, 64 and 30 L/m). Hydraulic tank capacity is 90 gal (342 L).

CONTROLS

- ▶ Fully proportional, excellent metering characteristics for precise boom movements. Independent outrigger controls allow the crane to be stable and level in rigorous working conditions. Load Moment Indication System has audio alarm and functional shut down when operator encounters an overload situation.

OUTRIGGERS

- ▶ Front outriggers are Link-Type. The maximum width over main outrigger pad is 21' 9" (6.62 m), main outrigger spread at maximum ground penetration is 21' 4" (6.51 m).
- ▶ Rear outriggers are Out & Down type. The maximum width over auxiliary outrigger pads is 17' 6" (5.34 m).

SUBFRAME

- ▶ Single fabricated, closed-box style subframe yields greater strength and rigidity. Wheelbase for standard truck crane mounting configuration is 261" (6.62 m).

OPTIONS AND ACCESSORIES

- ▶ Single and two-stage jibs
- ▶ Multi-part load blocks
- ▶ Main winch with 2 speed motor
- ▶ Auxiliary winch
- ▶ Rotation-resistant load line
- ▶ Heavy duty wood flatbed
- ▶ Extra heavy duty wood flatbeds
- ▶ Extra heavy duty steel flatbeds
- ▶ Radio remote controls
- ▶ One-man or two-man baskets
- ▶ Self-leveling work platform
- ▶ Winch drum tensioner
- ▶ Continuous rotation
- ▶ Oil cooler
- ▶ Single front bumper outrigger (required for 370° or continuous rotation)
- ▶ Hydraulic hose reel
- ▶ Hydraulic auxiliary tool circuit
- ▶ Toolbox

MODERN CRANE



BOOM TRUCK CRANE STINGER 4792

RM MODEL

SPECIFICATIONS

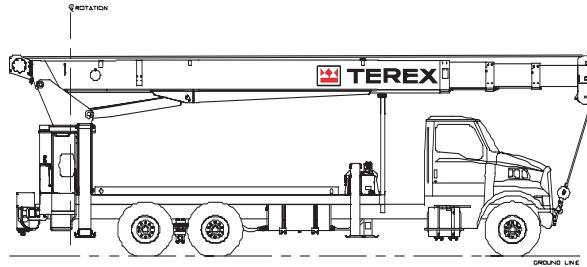

BOOM

- ▶ 29-92' (8.84-28.04 m) four-section full power fully synchronized boom. Patented keel boom design utilizes a keel shaped base plate combined with a deep, four plate boom section to optimize strength / rigidity-to-height ratio. Exclusive, patented color-coded boom and load charts allow the operator to easily determine boom extension, boom angle and load capacity. Maximum tip height with four-section 29-92' (8.84-28.04 m) boom is 101' (30.78 m). Maximum tip height with optional two-stage 26-44' (7.92-13.41 m) jib is 144' (43.89 m).

WINCH

- ▶ Hydraulic winch with gear motor and planetary reduction gearing provides 2-speed operation. First layer rope pull is 11,400 lb (5 170 kg). Wire rope size is 9/16" (14 mm) with 37,000 lb (16 783 kg) breaking strength.

OPERATING SPEEDS

- ▶ Mainframe / turret assembly planetary gear rotation provides 180° rotation (370° with optional front bumper outrigger). Swing rotation is 75 seconds. Boom up/down is 41/30 seconds and boom extend/retract is 80/36 seconds.

HYDRAULICS

- ▶ Three-section pump allows the operator to perform simultaneous crane operations (winch, boom and swing). Capacities are 32, 17 and 8 gpm (122, 64 and 30 L/m). Hydraulic tank capacity is 90 gal (342 L).

CONTROLS

- ▶ Fully proportional, excellent metering characteristics for precise boom movements. Independent outrigger controls allow the crane to be stable and level in rigorous working conditions. Load Moment Indication System has audio alarm and functional shut down when operator encounters an overload situation.

OUTRIGGERS

- ▶ Rear outriggers are Link-Type. The maximum width over main outrigger pad is 21' 9" (6.62 m), main outrigger spread at maximum ground penetration is 21' 4" (6.51 m).
- ▶ Front outriggers are Out & Down type. The maximum width over auxiliary outrigger pads is 17' 6" (5.34 m).

SUBFRAME

- ▶ Single fabricated, closed-box style subframe yields greater strength and rigidity. Wheelbase for standard truck crane mounting configuration is 261" (6.62 m).

OPTIONS AND ACCESSORIES

- ▶ Single and two-stage jibs
- ▶ Multi-part load blocks
- ▶ Main winch with 2 speed motor
- ▶ Auxiliary winch
- ▶ Rotation-resistant load line
- ▶ Heavy duty wood flatbed
- ▶ Extra heavy duty wood flatbeds
- ▶ Extra heavy duty steel flatbeds
- ▶ Radio remote controls
- ▶ One-man or two-man baskets
- ▶ Self-leveling work platform
- ▶ Winch drum tensioner
- ▶ Continuous rotation
- ▶ Oil cooler
- ▶ Tool Box
- ▶ Hydraulic hose reel
- ▶ Hydraulic auxiliary tool circuit

MODERN CRANE



TEREX

STINGER 4792 | Contacts

SALES

Tom Limbach

Sales Director, Terex Cranes
Office: (319) 352-9357
Mobile: (815) 703-3905
Office Fax: (319) 352-9395
Email: tom.limbach@terexwaverly.com

Diane Sheedy

Director of International Sales
Office: (319) 352-9326
Office Fax: (319) 352-9395
Email: diane.sheedy@terexwaverly.com

Bruce Kramer

Sales Manager, Terex Cranes
Office: (319) 352-9347
Mobile: (815) 703-3896
Office Fax: (319) 352-9395
Email: bruce.kramer@terexwaverly.com

Chad Brandenburg

Sales Coordinator, Terex Cranes
Office: (319) 352-9356
Mobile: (910) 367-3152
Office Fax: (319) 352-9395
Email: chad.brandenburg@terexwaverly.com

Angie Scribner

Sales Assistant, Terex Cranes
Office: (319) 352-9309
Office Fax: (319) 352-9395
Email: angie.scribner@terexwaverly.com

SERVICE – PARTS

Roger Jones

Service Manager – Product Support
Office: (910) 395-8504
Mobile: (910) 367-6260
Office Fax: (910) 395-8538
Email: rjones@american-crane.com

Dino Nelson

Service Training Specialist
Office: (319) 352-9338
Mobile: (815) 703-1800
Office Fax: (319) 352-9378
Email: dino.nelson@terexwaverly.com

Jim Chivers (Boom Trucks)

Service Manager – Product Support
Office: (319) 352-9352
Mobile: (815) 703-3901
Office Fax: (319) 352-9378
Email: jim.chivers@terexwaverly.com

Fred Backer (Boom Trucks)

Service Technician
Office: (319) 352-9388
Mobile: (815) 703-6514
Office Fax: (319) 352-9378
Email: fred.backer@terexwaverly.com

Dan Kalkbrenner (RT & T Cranes)

Service Manager - Product Support
Office: (319) 352-9368
Mobile: (815) 703-3900
Office Fax: (319) 352-9378
Email: dan.kalkbrenner@terexwaverly.com

Jim Dawson (RT & T Cranes)

Service Manager - Product Support
Office: (319) 352-9366
Mobile: (815) 703-3899
Office Fax: (319) 352-9378
Email: jim.dawson@terexwaverly.com

PARTS

Peggy Pellican

Director of Aftermarket Sales
Office: (336) 644-0536
Mobile: (336) 442-8348
Office Fax: (336) 644-0495
Fax: (801) 991-8193
Email: ppellican@terexparts.com

QUALITY ASSURANCE

Lee Linderkamp

Quality Assurance Manager
Office: (319) 352-9364
Mobile: (815) 703-3898
Office Fax: (319) 352-9378
Email: lee.linderkamp@terexwaverly.com

Clint Schrage

Warranty Manager
Office: (319) 352-9305
Office Fax: (319) 352-9378
Email: clint.schrage@terexwaverly.com

ENGINEERING

George Green

Director of Engineering
Office: (319) 352-9315
Office Fax: (319) 352-9378
Email: george.green@terexwaverly.com

Dave Schoonover (Boom Trucks)

Project Engineer
Office: (319) 352-9372
Office Fax: (319) 352-9378
Email: dave.schoonover@terexwaverly.com

Brian Thomas (RT Cranes)

Project Engineer
Office: (319) 352-9386
Office Fax: (319) 352-9378
Email: brian.thomas@terexwaverly.com

Dave Frerking (T Cranes)

Project Engineer
Office: (319) 352-9321
Office Fax: (319) 352-9378
Email: dave.frerking@terexwaverly.com

MANAGEMENT

Dan Micheau

Operations Manager, Terex Cranes
Office: (319) 352-9314
Mobile: (815) 703-3903
Office Fax: (319) 352-5727
Email: dan.micheau@terexwaverly.com

TEREX Cranes
106-12th Street S.E.
Waverly, IA 50677-9466 USA

TEL (319) 352-3920
FAX (319) 352-5727
EMAIL inquire@terexwaverly.com
WEB terex.com

For more information, product demonstration, or detail on purchase, lease and rental plans, please contact your local Terex Crane dealer. We reserve the right to amend these specifications at anytime without notice. The only warranty applicable is our standard written warranty applicable to the particular product an sale. We make no other warranty, expressed or implied.

February 28, 2005

www.moderncrane.ca - (866) 552-7263