

# GR-350XL

35 US TON MAX. CRANE CAPACITY

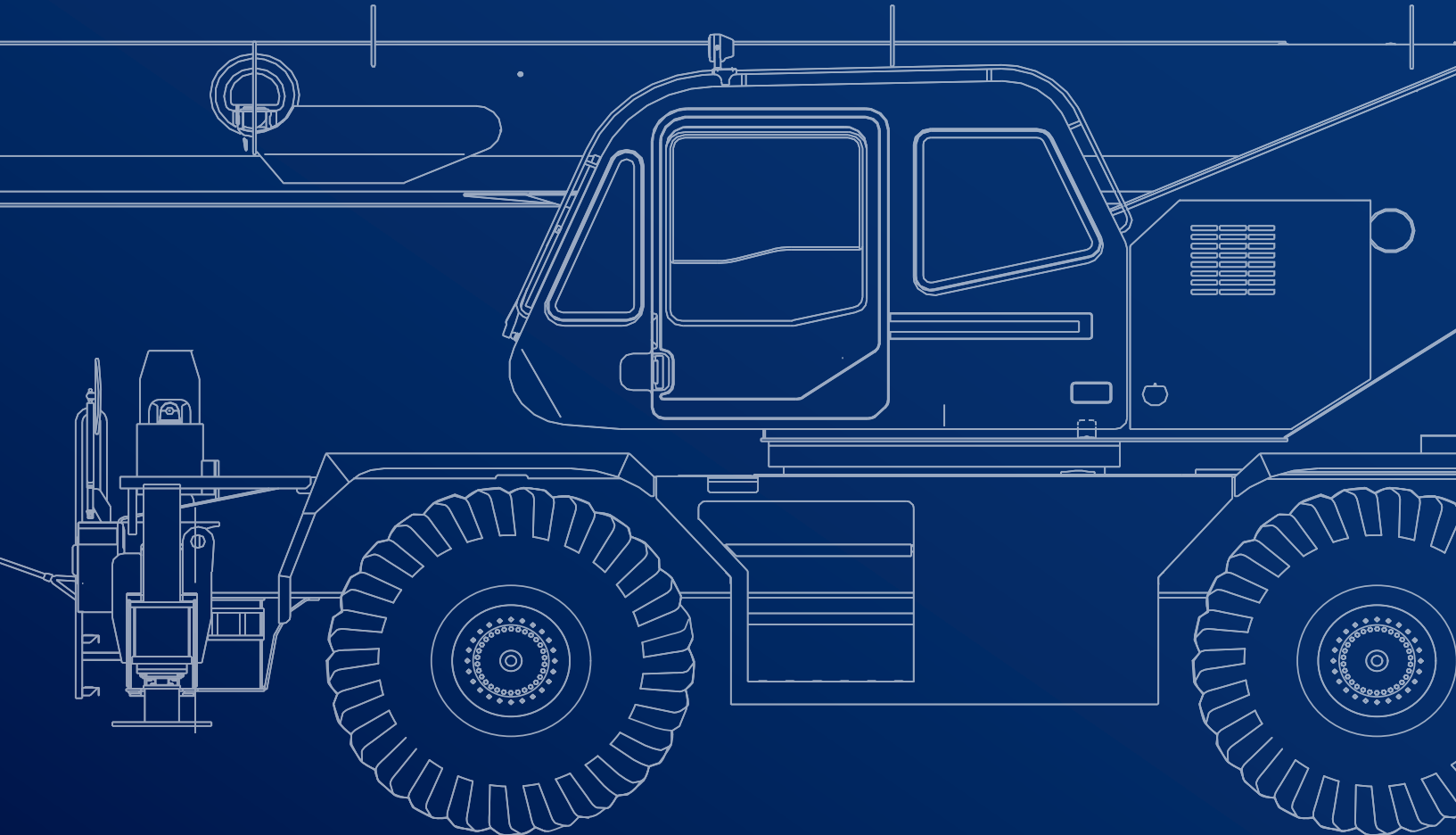

- Suitable for alternative fuels





February 2025. Unless otherwise specified, all information in this brochure refers to a standard crane equipment, and it is intended as general information only. No liability is assumed. Errors reserved. Product specifications and prices are subject to changes without notice. The photographs and/or drawings in this brochure are for illustrative purposes only. For correct and safe crane operation, the original operating manual and lifting capacity charts are essential. Failure to follow the corresponding Operator's Manual when using our equipment or failure to otherwise act responsibly may result in property damage, serious injury or death. The sole warranty applicable with respect to our equipment is the standard warranty as per general terms and conditions of sales and service (ask your local Tadano dealer for details), and Tadano makes no other warranty, express or implied. All rights reserved. Any use of the trademarks, logos, brand names and model names used herein is prohibited.

© Tadano Ltd. 2025

# Contents

<b>Specifications</b>	<b>5</b>
Vehicle dimensions .....	6-7
General dimensions .....	7
<b>Off-road driving</b>	<b>9</b>
Axle weight distribution chart .....	10
Speeds and gradeability .....	10
Steering.....	10
<b>Operation</b>	<b>11</b>
Main boom .....	12
Slewing .....	12
Hoist .....	12
Outrigger cylinders .....	12
Hook blocks .....	12
Line speeds and pulls .....	13
Drum wire rope capacities .....	13
Drum dimensions .....	13
<b>MB:</b> Main boom.....	14-18
<b>FJ:</b> Folding swing-away jib.....	20-22
Notes to Lifting Capacity .....	23
Warning and Operating Instructions for on Rubber Lifting Capacities .....	24
Notes for Load Moment Indicator (AML-C) .....	24
<b>Technical Description</b>	<b>25</b>
Crane specifications.....	26-27
Carrier specifications.....	27
Standard equipment.....	28-29

# Key

	Counterweight		Max. line pull
	Lifting capacities on outriggers · 360°		Rope diameter
	Radius		Rope length
	Main boom		Hook block
	Main boom length		Number of lines
	Folding swing-away jib		Number of sheaves in hook block
	Tires		Line pulls available
	Hook block		Possible load of hook block
	Hook ball		Weight of hook block
	Hoist		Distance head sheave axle – hook ground
	Travel speed		Max. outrigger load
	Gradeability		Length of stroke (support cylinders)
	Working speeds		Base machine
	Rope		Gross vehicle weight
	Base jib		Weight on front axle
	Top jib		Weight on rear axle
	Boom telescoping		Wire rope layer
	Boom elevation		Total wire rope
	Slewing		

# SPECIFICATIONS

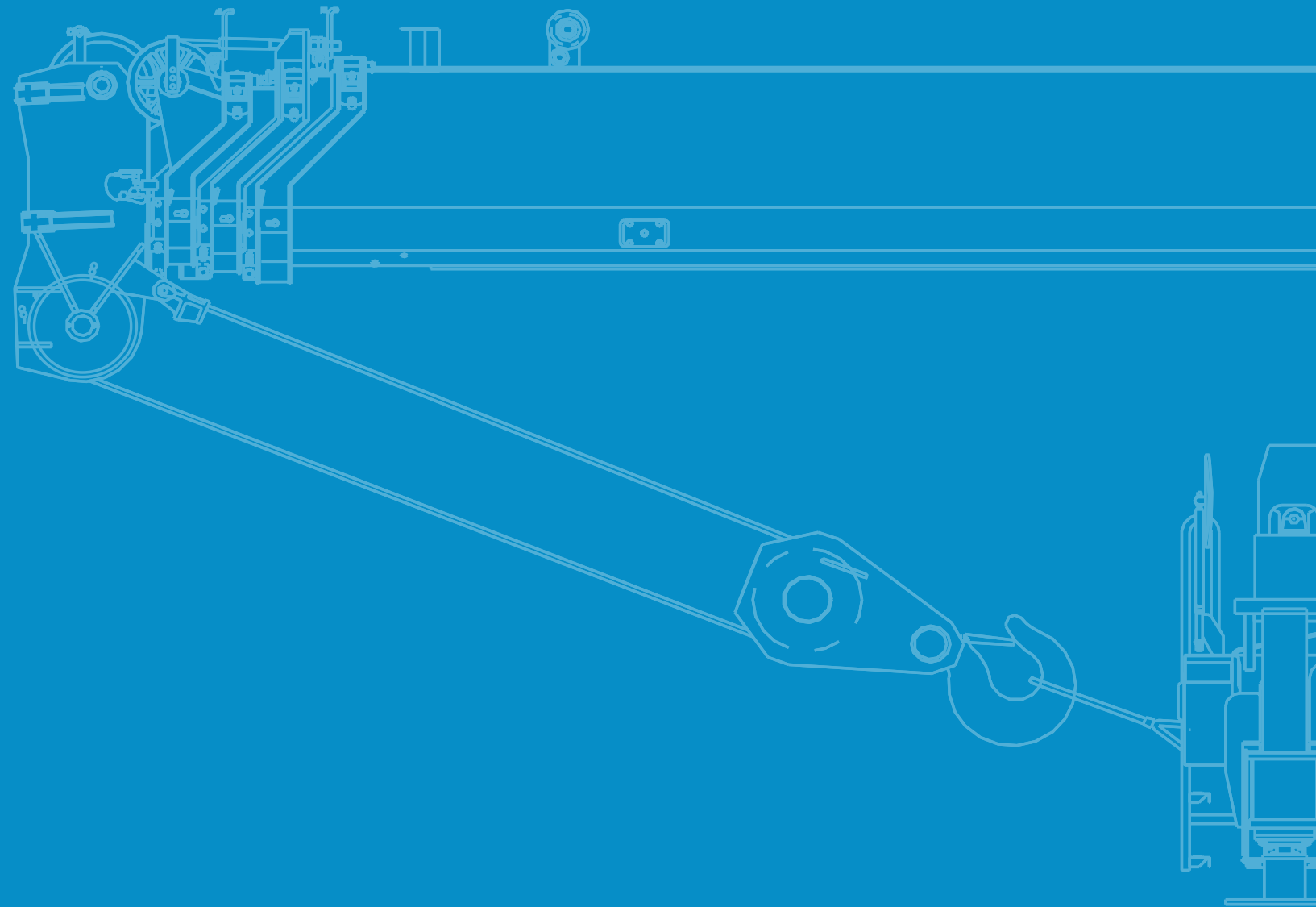

# Specifications

## Vehicle dimensions

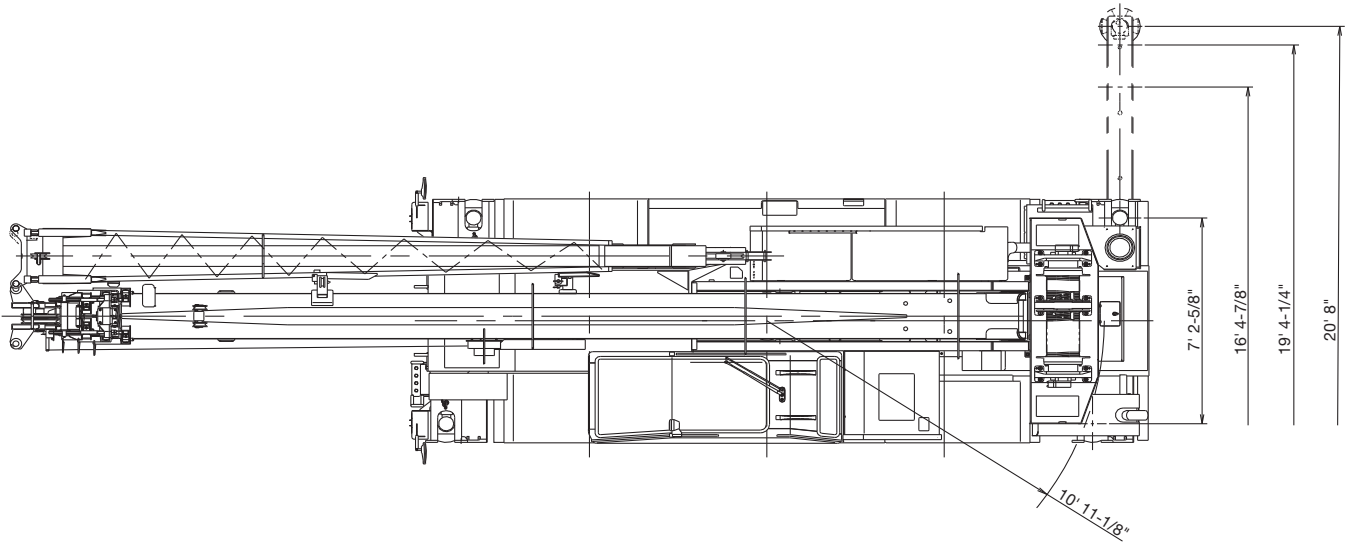
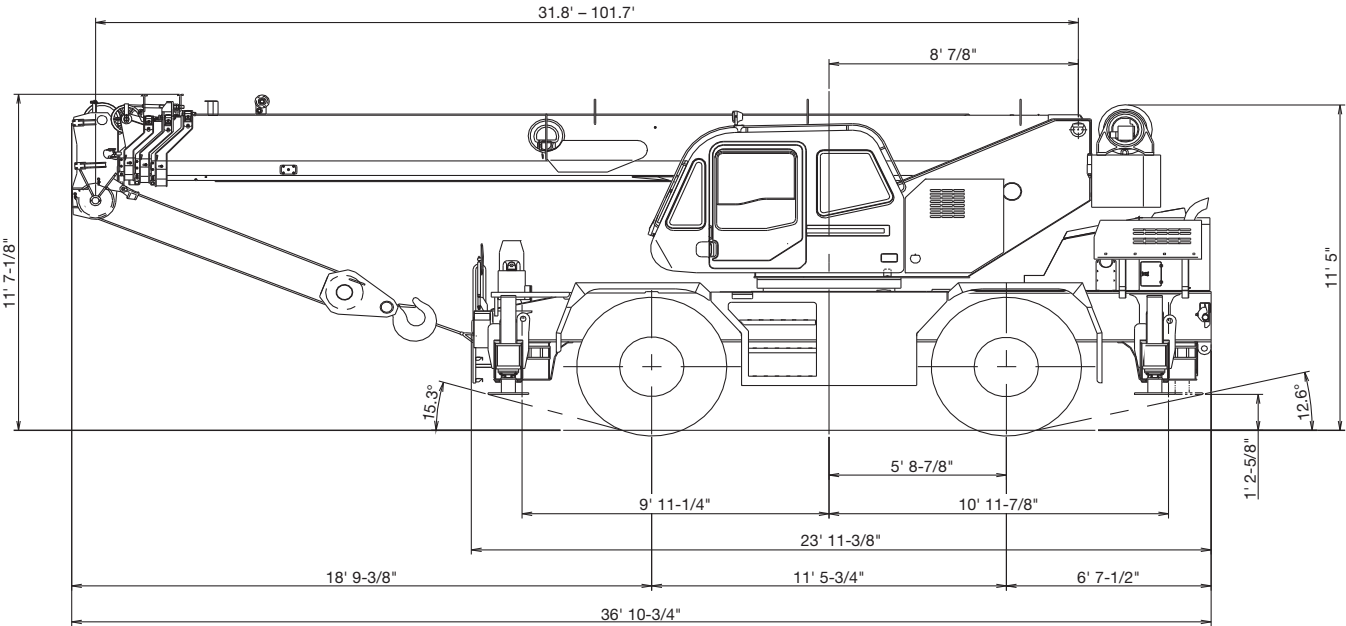

Dimension is with boom angle at 0 degree.

# Specifications

## Vehicle dimensions

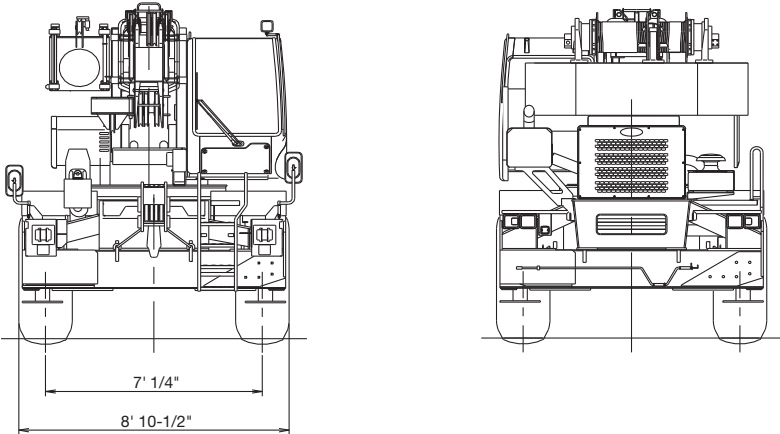

## General dimensions

Overall length	approx. 36' 10-3/4"
Overall width	approx. 8' 10-1/2"
Overall height	approx. 11' 7-1/8"
Turning radius: 4 wheel steer*	21' 4"
Turning radius: 2 wheel steer*	37' 5"
Tail swing of counterweight*	10' 11-1/8"

\* 20.5-25 tires





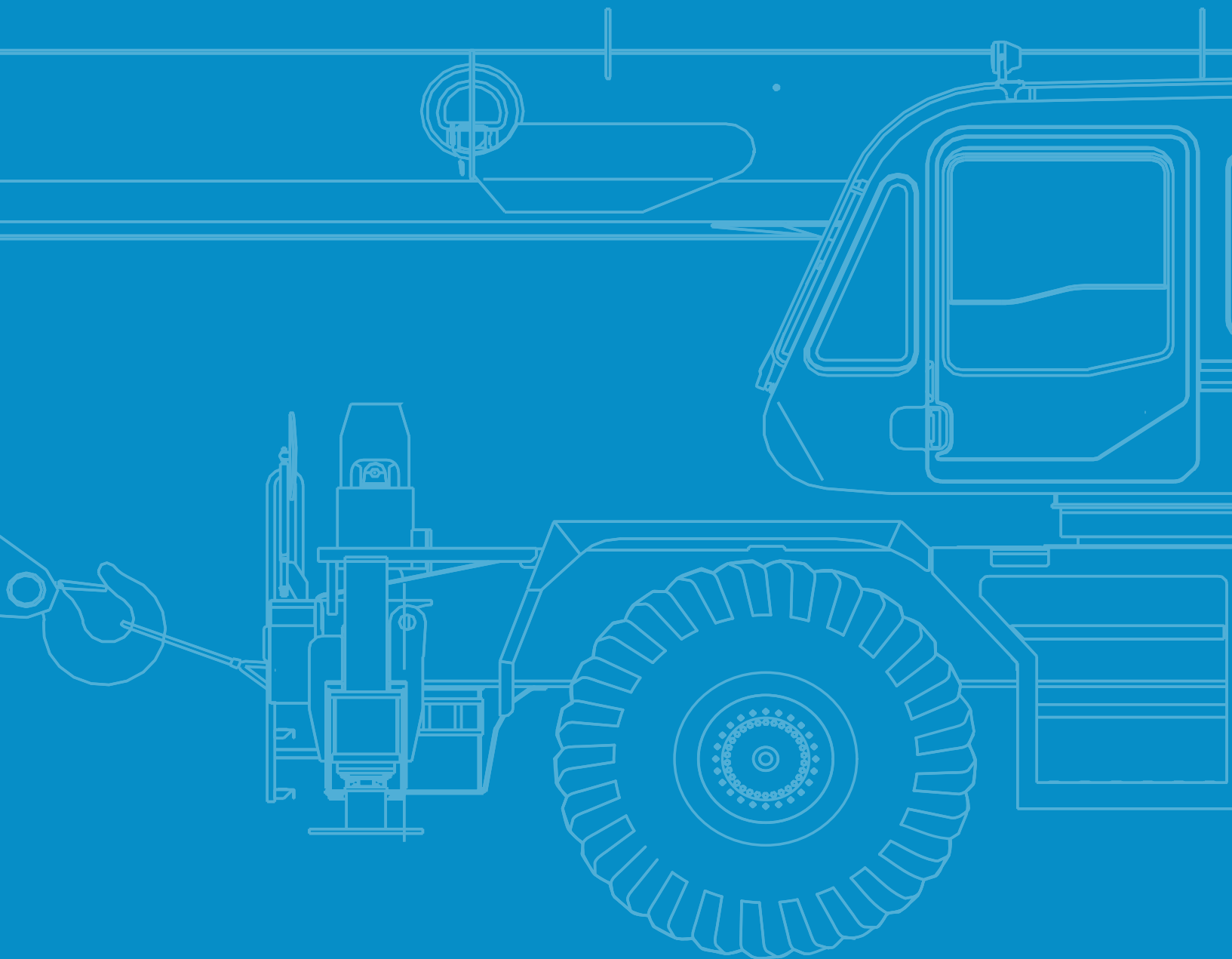

# TECHNICAL DATA FOR OFF-ROAD DRIVING



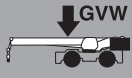
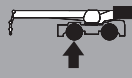
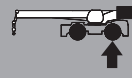
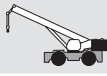

# Off-road driving



## Axle weight distribution chart

	 GVW		
	60,830 lb	30,380 lb	30,450 lb
<b>Remove:</b>			
 4.4 ton	-220 lb	-310 lb	90 lb
 35 ton	-620 lb	-1,100 lb	480 lb
2-stage jib	-1,390 lb	-2,390 lb	1,000 lb
Auxiliary lifting sheave	-110 lb	-270 lb	160 lb

## Speeds and gradeability

	20.5-25 (OR)
 %	78 % at stall  57 % Machine should be operated within the limit of engine crankcase design (30°: Cummins B6.7)
	31 mph

## Steering

	4 wheel steer
	2 wheel steer

# TECHNICAL DATA FOR OPERATION

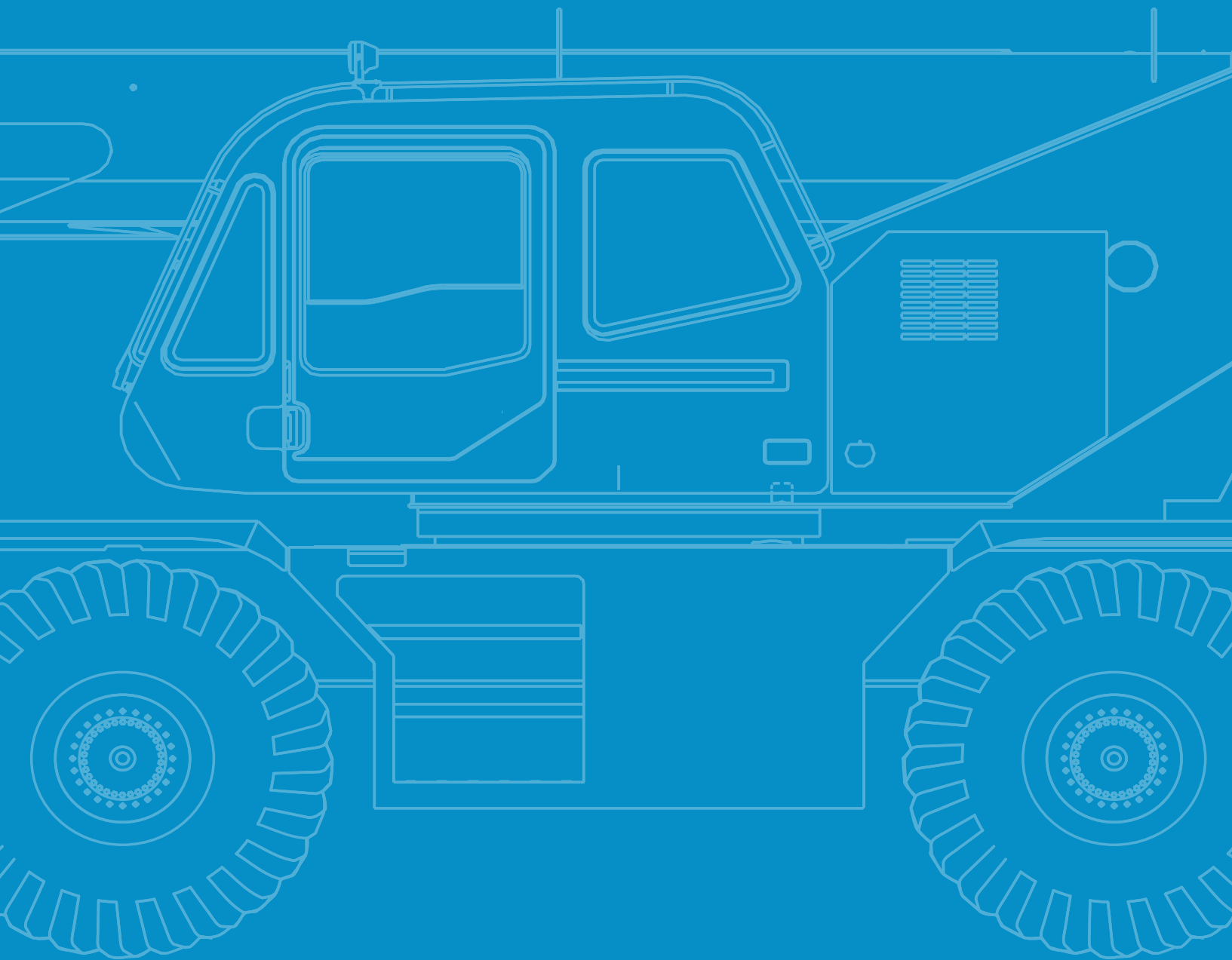

# Operation

## Main boom

	approx. 91 s (31.8 ft - 101.7 ft)		0° - 81° approx. 22 s (20° - 60°)
--	-----------------------------------	--	--------------------------------------

## Slewing

	3.2 min <sup>-1</sup>
--	-----------------------

## Hoist

	436 ft/min	12,600 lb	5/8"	558'
	436 ft/min	12,600 lb	5/8"	322'

## Outrigger cylinders

	56,200 lb	56,200 lb
	23.2"	23.2"



## Hook Blocks

4.4 ton	8,800 lb	—	1	220 lb	6.5 ft
35.0 ton	70,000 lb	4	8	620 lb	6.1 ft

# Operation

## Line speeds and pulls

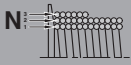
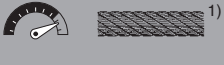
### Main or auxiliary hoist - 12'-5/8" drum



	 1)	 2)
1	328 ft/min.	12,600 lb
2	354 ft/min.	11,500 lb
3	384 ft/min.	10,500 lb
4	410 ft/min.	9,700 lb
5	436 ft/min.	9,000 lb
6 <sup>3)</sup>	466 ft/min.	8,400 lb

Maximum permissible line pull may be affected by wire rope strength. Maximum lifting capacity per line (main + aux.): 8,820 lb.

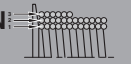

- 1) Line speeds based only on hook block, not loaded.
- 2) Developed by machinery with each layer of wire rope, but not based on rope strength or other limitation in machinery or equipment.
- 3) Sixth layer of wire rope are not recommended for hoisting operations.

## Drum wire rope capacities

### Main drum grooved lagging 5/8" wire rope

		$\Sigma$ 
1	98.8 ft	98.8 ft
2	107.6 ft	206.4 ft
3	115.8 ft	322.2 ft
4	124.0 ft	446.2 ft
5	132.9 ft	579.1 ft
6	141.0 ft	720.1 ft

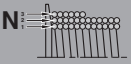
### Auxiliary drum grooved lagging 5/8" wire rope

		$\Sigma$ 
1	53.8 ft	53.8 ft
2	58.4 ft	112.2 ft
3	63.0 ft	175.2 ft
4	67.6 ft	242.8 ft
5	72.2 ft	315.0 ft
6	76.7 ft	391.7 ft

## Drum dimensions

Root diameter	12-5/8"
Length: Main	19-1/16"
Auxiliary	10-3/8"
Flange diameter	20-7/8"

# Operation



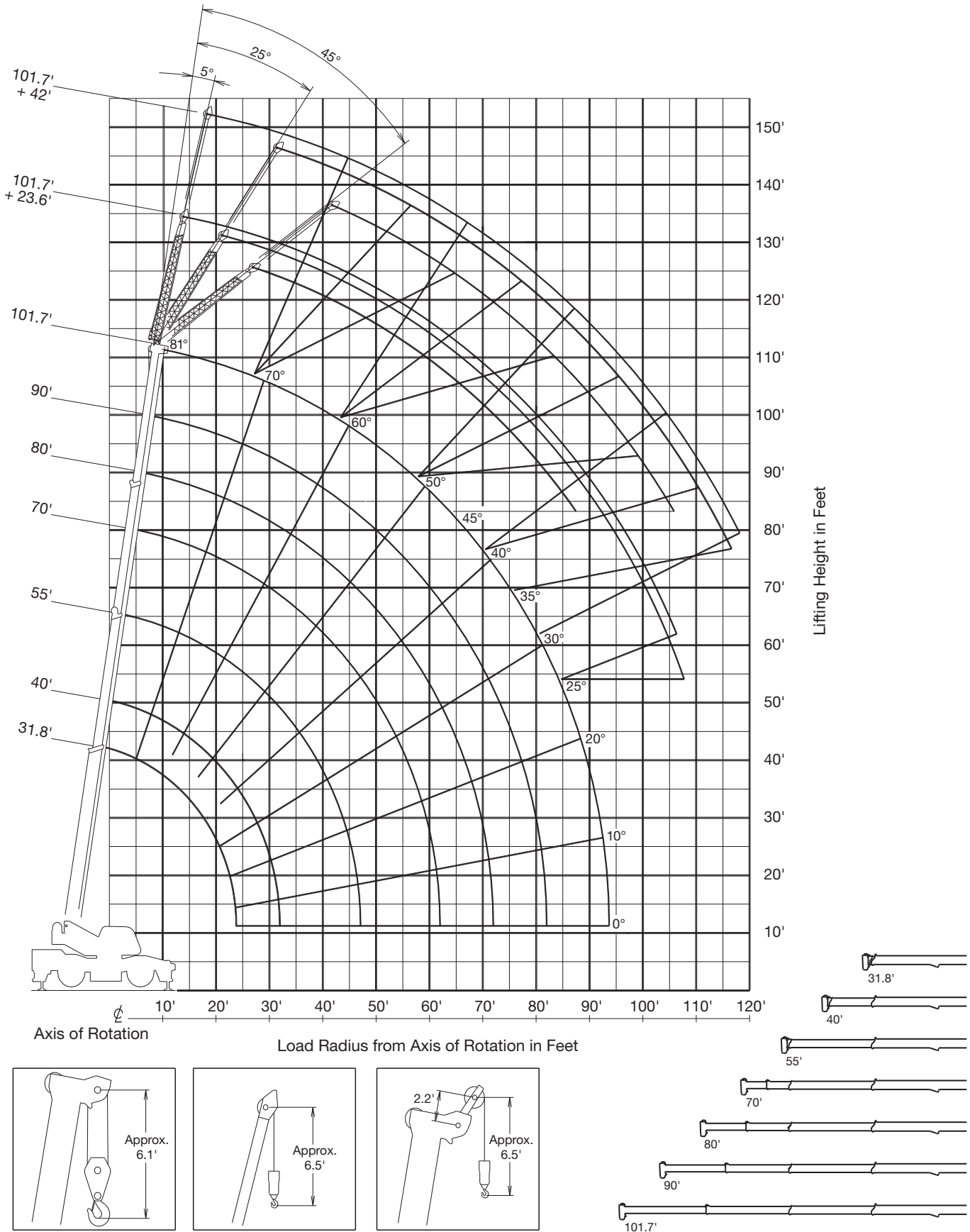













MB



NOTE: Boom and jib geometry shown are for unloaded condition and machine standing level on firm supporting surface. Boom deflection and subsequent radius and boom angle change must be accounted for when applying load to hook.

# Operation

Fully extended – 360°



5,300 lb		20' 8" x 20' 11"										360°				
																
ft		31.8' <sup>1)</sup>	31.8'	40' <sup>1)</sup>	40'	55' <sup>1)</sup>	55'	70' <sup>1)</sup>	70'	80' <sup>1)</sup>	80'	90' <sup>1)</sup>	90'	101.7' <sup>1)</sup>	101.7'	ft
1,000 lb																
8	65°	70,000	-	-	-	-	-	-	-	-	-	-	-	-	-	8
10	60°	60,000	67°	49,600	74°	42,300	78°	27,500	-	-	-	-	-	-	-	10
12	56°	56,500	64°	49,600	72°	42,300	76°	27,500	78°	27,500	-	-	-	-	-	12
15	49°	46,500	59°	46,000	69°	40,000	74°	27,500	76°	27,500	78°	25,300	-	-	-	15
20	34°	36,000	50°	35,500	63°	32,000	69°	27,500	72°	27,200	75°	23,500	77°	18,500	-	20
25	-	-	38°	28,500	57°	25,900	65°	24,200	69°	22,700	72°	20,400	75°	18,100	-	25
30	-	-	22°	20,500	50°	20,100	60°	20,100	65°	19,400	68°	17,800	72°	16,300	-	30
35	-	-	-	-	42°	15,800	55°	16,700	60°	16,000	65°	15,300	68°	14,400	-	35
40	-	-	-	-	33°	12,200	50°	13,100	56°	13,250	61°	13,050	65°	12,600	-	40
45	-	-	-	-	19°	9,250	44°	10,300	51°	10,600	57°	11,000	62°	11,000	-	45
50	-	-	-	-	-	-	37°	8,400	46°	8,700	53°	8,900	59°	9,300	-	50
55	-	-	-	-	-	-	29°	6,650	41°	7,100	49°	7,300	55°	7,800	-	55
60	-	-	-	-	-	-	16°	5,400	34°	5,900	44°	6,200	51°	6,450	-	60
65	-	-	-	-	-	-	-	-	27°	4,800	39°	5,100	47°	5,300	-	65
70	-	-	-	-	-	-	-	-	15°	3,700	33°	4,300	43°	4,400	-	70
75	-	-	-	-	-	-	-	-	-	-	25°	3,650	38°	3,800	-	75
80	-	-	-	-	-	-	-	-	-	-	15°	3,000	33°	3,200	-	80
85	-	-	-	-	-	-	-	-	-	-	-	-	27°	2,600	-	85
90	-	-	-	-	-	-	-	-	-	-	-	-	18°	2,200	-	90
	<sup>2)</sup>	0°	0°	0°	0°	0°	0°	0°	0°	0°	0°	0°	0°	0°		
		31.8'	40'	55'	70'	80'	90'	101.7'								
		23.7'	31.9'	46.9'	61.9'	71.9'	81.9'	93.6'								
	<sup>1)</sup> 0°	30,400 lb	18,700 lb	8,600 lb	5,000 lb	3,400 lb	2,800 lb	1,900 lb								

1) Loaded boom angle (°)

2) Minimum boom angle (°) for indicated length (no load)

**NOTE:**

The lifting capacity data stored in the LOAD MOMENT INDICATOR (AML-C) is based on the standard number of parts of line listed in the chart. Standard number of parts of line for each boom length should be according to the following table.

	31.8'	31.8' to 55'	55' to 101.7'	Single top jib
	8	6	4	1

# Operation

## Mid extended – 360°

5,300 lb		19' 4-1/4" x 20' 11"										360°																					
				31.8' <sup>1)</sup>		31.8'		40' <sup>1)</sup>		40'		55' <sup>1)</sup>		55'		70' <sup>1)</sup>		70'		80' <sup>1)</sup>		80'		90' <sup>1)</sup>		90'		101.7' <sup>1)</sup>		101.7'			
ft																														ft			
8	65°	70,000	-	-	-	-	-	-	-	-	-	-	-	-	-	-	-	-	-	-	-	-	-	-	-	-	-	-	-	8			
10	60°	60,000	67°	49,600	74°	42,300	78°	27,500	-	-	-	-	-	-	-	-	-	-	-	-	-	-	-	-	-	-	-	-	-	10			
12	56°	56,500	64°	49,600	72°	42,300	76°	27,500	78°	27,500	-	-	-	-	-	-	-	-	-	-	-	-	-	-	-	-	-	-	-	12			
15	49°	46,500	59°	46,000	69°	40,000	74°	27,500	76°	27,500	78°	25,300	-	-	-	-	-	-	-	-	-	-	-	-	-	-	-	-	-	15			
20	34°	34,700	50°	35,500	63°	32,000	69°	27,500	72°	27,200	75°	23,500	77°	18,500	-	-	-	-	-	-	-	-	-	-	-	-	-	-	-	20			
25	-	-	38°	24,000	57°	23,700	65°	24,200	69°	22,700	72°	20,400	75°	18,100	-	-	-	-	-	-	-	-	-	-	-	-	-	-	-	25			
30	-	-	22°	16,700	50°	16,500	60°	17,900	65°	18,300	68°	17,300	72°	16,300	-	-	-	-	-	-	-	-	-	-	-	-	-	-	-	30			
35	-	-	-	-	42°	12,250	55°	13,400	60°	13,850	65°	14,150	68°	13,250	-	-	-	-	-	-	-	-	-	-	-	-	-	-	-	35			
40	-	-	-	-	33°	9,050	49°	10,300	56°	10,700	61°	11,200	65°	11,200	-	-	-	-	-	-	-	-	-	-	-	-	-	-	-	40			
45	-	-	-	-	19°	6,750	43°	8,000	51°	8,350	57°	8,800	62°	9,100	-	-	-	-	-	-	-	-	-	-	-	-	-	-	-	45			
50	-	-	-	-	-	-	37°	6,300	46°	6,700	53°	7,050	58°	7,300	-	-	-	-	-	-	-	-	-	-	-	-	-	-	-	50			
55	-	-	-	-	-	-	29°	4,850	41°	5,300	48°	5,700	55°	6,000	-	-	-	-	-	-	-	-	-	-	-	-	-	-	-	55			
60	-	-	-	-	-	-	16°	3,800	34°	4,200	44°	4,600	51°	4,800	-	-	-	-	-	-	-	-	-	-	-	-	-	-	-	60			
65	-	-	-	-	-	-	-	-	27°	3,300	38°	3,700	47°	4,000	-	-	-	-	-	-	-	-	-	-	-	-	-	-	-	65			
70	-	-	-	-	-	-	-	-	15°	2,600	33°	2,900	43°	3,200	-	-	-	-	-	-	-	-	-	-	-	-	-	-	-	70			
75	-	-	-	-	-	-	-	-	-	-	25°	2,300	38°	2,600	-	-	-	-	-	-	-	-	-	-	-	-	-	-	-	75			
80	-	-	-	-	-	-	-	-	-	-	15°	1,700	33°	2,000	-	-	-	-	-	-	-	-	-	-	-	-	-	-	-	80			
85	-	-	-	-	-	-	-	-	-	-	-	-	26°	1,400	-	-	-	-	-	-	-	-	-	-	-	-	-	-	-	85			
90	-	-	-	-	-	-	-	-	-	-	-	-	18°	800	-	-	-	-	-	-	-	-	-	-	-	-	-	-	-	90			
	0°	0°	0°	0°	0°	0°	0°	0°	0°	0°	0°	0°	0°	0°	0°	0°	0°	0°	0°	0°	0°	0°	0°	0°	0°	0°	0°	0°	0°	0°			
	31.8'	40'	55'	70'	80'	90'	101.7'																										
	23.7'	31.9'	46.9'	61.9'	71.9'	81.9'	93.6'																										
	26,500 lb	15,000 lb	6,000 lb	3,400 lb	2,300 lb	1,450 lb	500 lb																										

- 1) Loaded boom angle (°)
- 2) Minimum boom angle (°) for indicated length (no load)









**NOTE:**  
The lifting capacity data stored in the LOAD MOMENT INDICATOR (AML-C) is based on the standard number of parts of line listed in the chart. Standard number of parts of line for each boom length should be according to the following table.

	31.8'	31.8' to 55'	55' to 101.7'	Single top jib
	8	6	4	1



# Operation

Mid extended – 360°



5,300 lb		16' 4-7/8" x 20' 11"										360°			
ft	31.8 <sup>1)</sup>	31.8'	40 <sup>1)</sup>	40'	55 <sup>1)</sup>	55'	70 <sup>1)</sup>	70'	80 <sup>1)</sup>	80'	90 <sup>1)</sup>	90'	101.7 <sup>1)</sup>	101.7'	ft
	1,000 lb														
8	65°	70,000	-	-	-	-	-	-	-	-	-	-	-	-	8
10	60°	60,000	67°	49,600	74°	42,300	78°	27,500	-	-	-	-	-	-	10
12	56°	56,500	64°	49,600	72°	42,300	76°	27,500	78°	27,500	-	-	-	-	12
15	49°	46,500	59°	46,000	69°	40,000	74°	27,500	76°	27,500	78°	25,300	-	-	15
20	34°	28,300	50°	27,600	63°	27,000	69°	27,500	73°	27,200	75°	23,500	77°	18,500	20
25	-	-	38°	18,300	56°	17,800	65°	19,200	69°	19,600	72°	19,900	75°	18,100	25
30	-	-	22°	12,700	50°	12,700	60°	13,800	64°	14,200	68°	14,750	72°	15,000	30
35	-	-	-	-	42°	9,000	55°	10,000	60°	10,500	64°	11,000	68°	11,300	35
40	-	-	-	-	32°	6,500	49°	7,500	56°	8,000	61°	8,400	65°	8,700	40
45	-	-	-	-	19°	4,700	43°	5,700	51°	6,200	57°	6,500	62°	6,800	45
50	-	-	-	-	-	-	37°	4,300	46°	4,700	53°	5,100	58°	5,400	50
55	-	-	-	-	-	-	28°	3,200	40°	3,600	48°	4,000	55°	4,300	55
60	-	-	-	-	-	-	16°	2,300	34°	2,700	43°	3,100	51°	3,400	60
65	-	-	-	-	-	-	-	-	26°	2,000	38°	2,400	47°	2,600	65
70	-	-	-	-	-	-	-	-	15°	1,300	32°	1,700	42°	2,000	70
75	-	-	-	-	-	-	-	-	-	-	25°	1,200	38°	1,400	75
80	-	-	-	-	-	-	-	-	-	-	-	-	32°	1,000	80
	0°		0°		0°		0°		0°		0°		20°		
	31.8'		40'		55'		70'		80'		90'				
	23.7'		31.9'		46.9'		61.9'		71.9'		81.9'				
	20,700 lb		11,300 lb		4,100 lb		2,100 lb		1,100 lb		500 lb				

1) Loaded boom angle (°)

2) Minimum boom angle (°) for indicated length (no load)









**NOTE:**

The lifting capacity data stored in the LOAD MOMENT INDICATOR (AML-C) is based on the standard number of parts of line listed in the chart. Standard number of parts of line for each boom length should be according to the following table.

	31.8'	31.8' to 55'	55' to 101.7'	Single top jib
	8	6	4	1

# Operation

Min extended – 360°



5,300 lb		7' 2-5/8" x 20' 11"										360°			
ft	31.8 <sup>1)</sup>	31.8'	40 <sup>1)</sup>	40'	55 <sup>1)</sup>	55'	70 <sup>1)</sup>	70'	80 <sup>1)</sup>	80'	90 <sup>1)</sup>	90'	101.7 <sup>1)</sup>	101.7'	ft
8	65°	44,400	-	-	-	-	-	-	-	-	-	-	-	-	8
10	60°	28,600	67°	27,500	74°	27,900	78°	27,500	-	-	-	-	-	-	10
12	56°	20,900	64°	20,800	72°	20,300	76°	21,600	78°	22,700	-	-	-	-	12
15	49°	14,600	59°	14,100	68°	13,800	73°	15,000	76°	15,600	78°	16,500	-	-	15
20	33°	7,900	49°	8,200	62°	7,700	69°	8,900	72°	9,400	74°	10,000	77°	10,300	20
25	-	-	38°	4,900	56°	4,500	64°	5,600	68°	6,000	71°	6,500	74°	6,700	25
30	-	-	22°	2,600	49°	2,300	59°	3,400	64°	3,800	67°	4,200	70°	4,400	30
35	-	-	-	-	42°	1,000	54°	1,900	60°	2,300	64°	2,600	67°	2,900	35
40	-	-	-	-	-	-	-	-	55°	1,200	60°	1,500	64°	1,800	40
	0°	0°	36°	45°	51°	54°	58°								
	31.8'	40'													
	23.7'	31.9'													
	5,600 lb	2,000 lb													

1) Loaded boom angle (°)

2) Minimum boom angle (°) for indicated length (no load)

**NOTE:**

The lifting capacity data stored in the LOAD MOMENT INDICATOR (AML-C) is based on the standard number of parts of line listed in the chart. Standard number of parts of line for each boom length should be according to the following table.

	31.8'	31.8' to 55'	55' to 101.7'	Single top jib
	8	6	4	1



# Operation

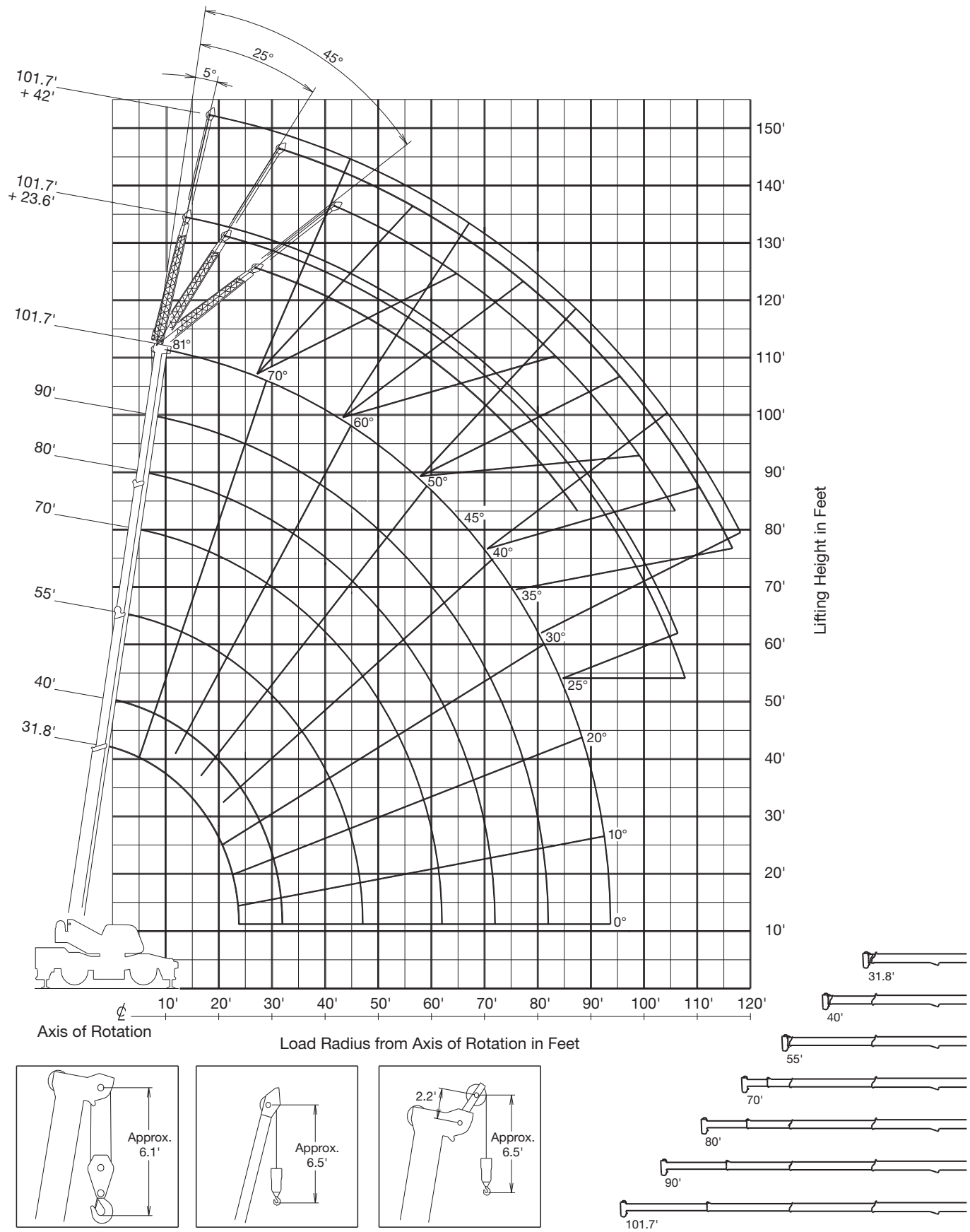

NOTE: Boom and jib geometry shown are for unloaded condition and machine standing level on firm supporting surface. Boom deflection and subsequent radius and boom angle change must be accounted for when applying load to hook.

# Operation

## Fully extended – 360°

5,300 lb							20' 8" x 20' 11"							360°						
							101.7' + M 23.6'							101.7' + M 42.0'						
		5°		25°		45°				5°		25°		45°						
1)	2)	3)	2)	3)	2)	3)	1)	2)	3)	2)	3)	2)	3)	2)	3)					
80°	19.3'	7,700	26.7'	5,200	32.1'	3,700	80°	25.6'	4,800	38.0'	2,600	47.8'	1,700							
77.5°	25.2'	7,700	32.0'	5,000	37.2'	3,600	77.5°	32.2'	4,800	44.3'	2,600	53.4'	1,700							
75°	30.8'	7,700	37.5'	4,800	42.4'	3,500	75°	38.8'	4,800	50.4'	2,600	58.6'	1,700							
72.5°	36.4'	7,350	42.7'	4,600	47.1'	3,400	72.5°	44.9'	4,400	56.1'	2,450	63.9'	1,700							
70°	41.8'	7,000	47.7'	4,400	52.1'	3,300	70°	50.9'	4,000	61.6'	2,300	68.9'	1,650							
67.5°	47.0'	6,600	52.9'	4,250	56.6'	3,200	67.5°	56.8'	3,700	67.1'	2,200	73.9'	1,600							
65°	52.0'	6,200	57.5'	4,100	61.0'	3,150	65°	62.3'	3,400	72.2'	2,050	78.5'	1,600							
62.5°	56.8'	5,700	62.4'	3,950	65.2'	3,100	62.5°	67.9'	3,150	77.4'	1,950	83.0'	1,550							
60°	61.4'	5,200	66.8'	3,800	69.5'	3,050	60°	73.1'	2,900	82.1'	1,850	87.3'	1,500							
57.5°	65.8'	4,700	71.2'	3,650	73.4'	3,000	57.5°	78.6'	2,750	86.7'	1,800	91.4'	1,450							
55°	70.3'	4,200	75.3'	3,500	77.4'	2,900	55°	83.5'	2,600	91.4'	1,750	95.4'	1,400							
52.5°	74.3'	3,700	79.2'	3,300	81.0'	2,800	52.5°	88.3'	2,450	95.9'	1,700	99.0'	1,400							
50°	78.4'	3,200	82.9'	3,100	84.5'	2,650	50°	93.0'	2,300	99.8'	1,600	102.0'	1,350							
47.5°	82.2'	2,900	86.2'	2,750	87.9'	2,500	47.5°	97.4'	2,100	104.0'	1,550	106.0'	1,350							
45°	85.8'	2,600	89.6'	2,400	90.9'	2,400	45°	102.0'	1,900	107.0'	1,500	110.0'	1,350							
42.5°	89.3'	2,300	92.8'	2,150	-	-	42.5°	105.0'	1,700	111.0'	1,400	-	-							
40°	92.6'	2,000	95.7'	1,900	-	-	40°	109.0'	1,500	114.0'	1,300	-	-							
37.5°	95.7'	1,750	98.6'	1,650	-	-	37.5°	113.0'	1,350	117.0'	1,150	-	-							
35°	98.6'	1,500	101.0'	1,400	-	-	35°	116.0'	1,200	120.0'	1,000	-	-							
32.5°	101.0'	1,350	104.0'	1,250	-	-	32.5°	119.0'	1,050	-	-	-	-							
30°	104.0'	1,200	106.0'	1,100	-	-	30°	122.0'	900	-	-	-	-							
27.5°	106.0'	1,050	108.0'	1,000	-	-	27.5°	-	-	-	-	-	-							
25°	108.0'	900	110.0'	900	-	-	25°	-	-	-	-	-	-							

- 1) Loaded boom angle (°)
- 2) Load radius in feet
- 3) Rated lifting capacity in pounds

## Mid extended – 360°

5,300 lb		19' 4-1/4" x 20' 11"		360°		
		101.7' + M 23.6'		101.7' + M 42.0'		
	5°	25°	45°	5°	25°	45°
1)	2)	3)	2)	3)	2)	3)
80°	19,3'	7.700	26,7'	5.200	32,1'	3.700
77,5°	25,2'	7.700	32,0'	5.000	37,2'	3.600
75°	30,8'	7.700	37,5'	4.800	42,4'	3.500
72,5°	36,4'	7.350	42,7'	4.600	47,1'	3.400
70°	41,8'	7.000	47,7'	4.400	52,1'	3.300
67,5°	47,1'	6.600	52,9'	4.250	56,6'	3.200
65°	52,1'	6.200	57,5'	4.100	61,0'	3.150
62,5°	56,7'	5.700	62,3'	3.950	65,4'	3.100
60°	61,1'	5.200	66,6'	3.800	69,5'	3.050
57,5°	65,6'	4.350	70,7'	3.500	73,5'	2.950
55°	69,9'	3.500	74,8'	3.200	77,2'	2.850
52,5°	74,0'	2.950	78,6'	2.750	80,9'	2.550
50°	78,0'	2.400	82,4'	2.300	84,2'	2.200
47,5°	81,8'	2.050	86,0'	1.950	87,6'	1.900
45°	85,3'	1.750	89,5'	1.650	90,7'	1.650
42,5°	88,9'	1.500	92,6'	1.350	-	-
40°	92,2'	1.200	95,6'	1.100	-	-

5,300 lb		16' 4-7/8" x 20' 11"		360°		
		101.7' + M 23.6'		101.7' + M 42.0'		
	5°	25°	45°	5°	25°	45°
1)	2)	3)	2)	3)	2)	3)
80°	19,3'	7.700	26,7'	5.200	32,1'	3.700
77,5°	25,2'	7.700	32,0'	5.000	37,2'	3.600
75°	30,8'	7.700	37,5'	4.800	42,4'	3.500
72,5°	36,4'	7.100	42,7'	4.600	47,1'	3.400
70°	41,5'	6.500	47,7'	4.400	52,1'	3.300
67,5°	46,7'	5.950	52,7'	4.350	56,6'	3.200
65°	51,5'	5.400	57,5'	4.100	61,0'	3.100
62,5°	56,1'	4.500	61,8'	3.650	65,2'	3.000
60°	60,5'	3.600	66,2'	3.200	69,3'	2.950
57,5°	64,8'	3.000	70,5'	2.700	73,1'	2.500
55°	69,2'	2.400	74,4'	2.200	76,9'	2.100
52,5°	73,4'	2.050	78,3'	1.750	80,3'	1.750
50°	77,2'	1.650	81,9'	1.400	83,8'	1.400
47,5°	81,4'	1.350	-	-	-	-
45°	85,0'	1.000	-	-	-	-

- 1) Loaded boom angle (°)
- 2) Load radius in feet
- 3) Rated lifting capacity in pounds

# Notes to Lifting Capacity

## GENERAL

1. RATED LIFTING CAPACITIES apply only to the machine as originally manufactured and normally equipped by TADANO LTD. Modifications to the machine or use of optional equipment other than that specified can result in a reduction of capacity.
2. Hydraulic cranes can be hazardous if improperly operated or maintained. Operation and maintenance of this machine must be in compliance with information in the **Operation and Maintenance Manual** supplied with the crane. If this manual is missing, order a replacement through the distributor.
3. The operator and other personnel associated with this machine shall fully acquaint themselves with the latest applicable ASME B30.5 safety standards for cranes as mentioned in OSHA CFR29 part 1926.

## SET UP

1. Rated lifting capacities on the load chart are the maximum allowable crane capacities. They are based on the machine standing level on firm supporting surface under ideal job conditions. Depending on the nature of the supporting surface, it may be necessary to have structural supports under the outrigger floats or tires to spread the loads to a larger surface.
2. For outrigger operation, outriggers shall be properly extended with tires free of supporting surface before operating crane.

## OPERATION

1. Rated lifting capacities have been tested to and meet minimum requirements of SAE J1063-Cantilevered Boom Crane Structures Method of Test.
2. Rated lifting capacities do not exceed 85 % of the tipping load on outriggers fully extended as determined by SAE J765-Crane Stability Test Code. Rated lifting capacities for partially extended outriggers are determined from the formula, rated lifting capacities = (tipping load - 0.1 x tip reaction) / 1.25.
3. Rated lifting capacities above bold lines in the chart are based on crane strength and those below, on its stability. They are based on actual load radius increased by boom deflection.
4. The weight of handling device such as hook blocks, slings, etc., must be considered as part of the load and must be deducted from the lifting capacities.
5. Rated lifting capacities are based on freely suspended loads and make no allowance for such factors as the effect of wind, sudden stopping of loads, supporting surface conditions, inflation of tires, operating speeds, side loads, etc. Side pull on the boom or jib is extremely dangerous.
6. Rated lifting capacities do not account for wind on lifted load or boom. We recommend against working under the condition that the load is out of control due to a strong wind. During boom lift, consider that the rated lifting capacity is reduced by 50% when the wind speed is 20 mph to 27 mph; reduced by 70% when the wind speed is 27 mph to 31 mph. If the wind speed is 31 mph or over, stop operation. During jib lift, stop operation if the wind speed is 20 mph or over.
7. Rated lifting capacities at load radius shall not be exceeded. Do not tip the crane to determine allowable loads.
8. Do not operate at boom lengths, radii, or boom angle, where no capacities are shown. Crane may overturn without any load on the hook.
9. When boom length is between values listed, refer to the rated lifting capacities of the next longer and next shorter booms for the same radius. The lesser of the two rated lifting capacities shall be used.
10. When making lifts at a load radius not shown, use the next longer radius to determine allowable capacity.
11. Load per line should not exceed 8,820 lb for main hoist and auxiliary hoist.
12. Check the actual number of parts of line with LOAD MOMENT INDICATOR (AML-C) before operation. Maximum lifting capacity is restricted by the number of parts of line of LOAD MOMENT INDICATOR (AML-C). Limited capacity is as determined from the formula, single line pull for main hoist 8,820 lb x number of parts of line.
13. The boom angle before loading should be greater to account for deflection. For rated lifting capacities, the loaded boom angle and the load radius is for reference only.
14. The 31.8' boom length capacities are based on boom fully retracted. If not fully retracted [less than 40' boom length], use the rated lifting capacities for the 40' boom length.
15. Extension or retraction of the boom with loads may be attempted within the limits of the RATED LIFTING CAPACITIES. The ability to telescope loads is limited by hydraulic pressure, boom angle, boom length, crane maintenance, etc.
16. For lifting capacity of single top, reduce the rated lifting capacities of relevant boom according to a weight reductions for auxiliary load handling equipment. Capacities of single top shall not exceed 8,820 lb including main hook.
17. When base jib or top jib or both jib removing, jib state switch select removed.
18. When erecting and stowing jib, be sure to retain it by hand or by other means to prevent its free movement.
19. Use "ANTI-TWO BLOCK" disable switch when erecting and stowing jib and when stowing hook block. While the switch is pushed, the hoist does not stop, even when overwind condition occurs.
20. For boom length with 23.6' jib, rated lifting capacities are determined by loaded boom angle only in the column headed „101.7' boom + 23.6' jib.“ For boom length with 42' jib, rated lifting capacities are determined by loaded boom angle only in the column headed „101.7' boom + 42' jib.“ For angles not shown, use the next lower loaded boom angle to determine allowable capacity.
21. When lifting a load by using jib (aux. hoist) and boom (main hoist) simultaneously, do the following:
  - Enter the operation status as jib operation, not as boom operation.
  - Before starting operation, make sure that mass of load is within rated lifting capacity for jib.

## DEFINITIONS

1. Load radius: Horizontal distance from a projection of the axis of rotation to supporting surface before loading to the center of the vertical hoist line or tackle with load applied.
2. Loaded boom angle: The angle between the boom base section and the horizontal, after lifting the rated lifting capacity at the load radius.
3. Working area: Area measured in a circular arc about the centerline of rotation.
4. Freely suspended load: Load hanging free with no direct external force applied except by the hoist line.
5. Side load: Horizontal side force applied to the lifted load either on the ground or in the air.

# Warning and Operating Instructions for on Rubber Lifting Capacities

1. Rated lifting capacities on rubber are in pounds and do not exceed 75 % of tipping loads as determined by SAE J765-Crane Stability Test Code.
2. Rated lifting capacities shown in the chart are based on condition that crane is set on firm level surfaces with axle oscillation lockout applied. Those above bold lines are based on tire capacity and those below, on crane stability. They are based on actual load radius increased by tire deformation and boom deflection.
3. If the axle oscillation lockout cylinders contain air, the axle will not be locked completely and rated lifting capacities may not be obtainable. Bleed the cylinders according to the operation safety and maintenance manual.
4. Rated lifting capacities are based on proper tire inflation, capacity and condition. Damaged tires are hazardous to safe operation of crane.
5. Tires shall be inflated to correct air pressure. Tires: 20.5-25 · Air pressure: 94 psi.
6. Over front operation shall be performed within 2 degrees in front of chassis.
7. On rubber lifting with "jib" is not permitted. Maximum permissible boom length is 70'.
8. When making lift on rubber stationary, set parking brake.
9. For creep operation, boom must be centered over front of machine, slewing lock engaged, and load restrained from slewing. Travel slowly and keep the lifted load as close to the ground as possible, and especially avoid any abrupt steering, accelerating or braking.
10. Do not operate the crane while carrying the load.
11. Creep is motion for crane not to travel more than 200' in any 30 minute period and to travel at the speed of less than 1 mph.
12. For creep operation, choose the drive mode and proper gear according to the road or working condition.

## Notes for Load Moment Indicator (AML-C)

1. When operating crane on outriggers:
  - Set „P.T.O.“ switch to "ON".
  - Press the outrigger mode select key to register for the outrigger operation. Press the register key, then the outrigger mode indicative symbol changes from flashing to a solid light.
  - Press the lift mode select key to select the lift status that corresponds to the actual boom configuration. Each time the lift mode select key is pressed, the status changes. Press the register key to register the lift status, then the lift indicative symbol changes from flashing to a solid light.
  - When mounting and stowing jib, select the jib set status (the jib state indicative symbol will be flashing).
2. When operating crane on rubber:
  - Set „P.T.O.“ switch to "ON".
  - Press the outrigger mode select key. The on-tire mode indicative symbol comes on. Each time the outrigger mode select key is pressed the status changes. Select the creep operation, the on-tire mode indicative symbol flicker.
  - Press the lift mode select key to register the boom or single top lift.

However, pay attention to the following.

  - (1) For stationary operation.
    - The front capacities are attainable only when the over front position symbol comes on. When the boom is more than 2 degrees from centered over front of chassis, 360° capacities are in effect.
    - When a load is lifted in the front position and then swung to the side area, make sure the value of the LOAD MOMENT INDICATOR (AML-C) is below the 360° lifting capacity.
  - (2) For creep operation.
    - The creep capacities are attainable only when boom is in the straight forward position of chassis and the over front position symbol is on. If boom is not in the straight forward position of chassis, never lift load.
3. A slewing does not automatically stop even if the crane becomes overloaded.
4. During crane operation, make sure that the displays on front panel are in accordance with actual operating conditions.
5. The displayed values of LOAD MOMENT INDICATOR (AML-C) are based on freely suspended loads and make no allowance for such factors as the effect of wind, sudden stopping of loads, supporting surface conditions, inflation of tire, operating speed, side loads, etc. For safe operation, it is recommended when extending and lowering boom or slewing, lifting loads shall be appropriately reduced.
6. LOAD MOMENT INDICATOR (AML-C) is intended as an aid to the operator. Under no condition should it be relied upon to replace use of capacity charts and operating instruction. Sole reliance upon LOAD MOMENT INDICATOR (AML-C) aids in place of good operating practice can cause an accident. The operator must exercise caution to assure safety.



# TECHNICAL DESCRIPTION

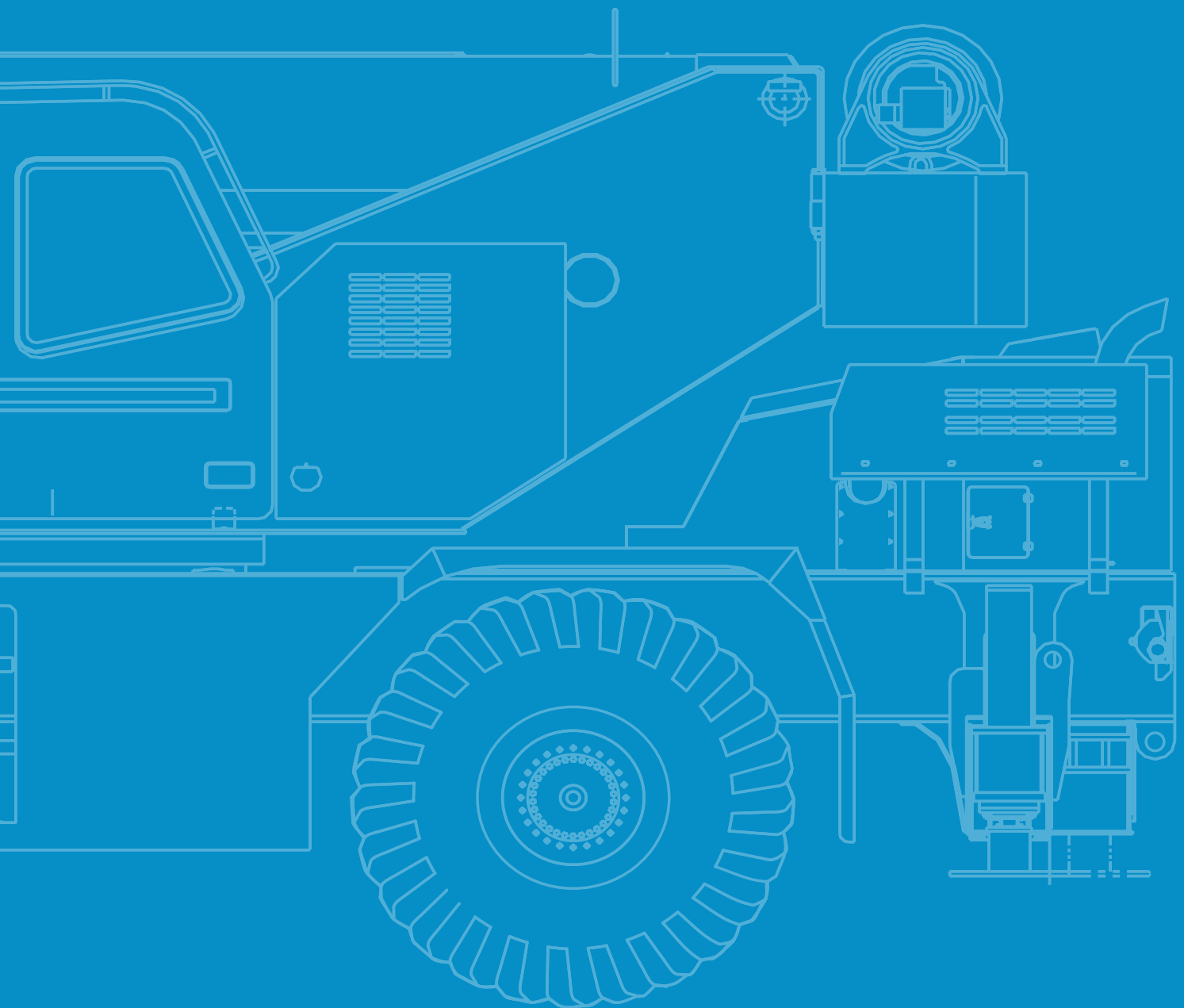

# Technical Description

## Crane specifications

<b>Boom</b>	Four section full power synchronized telescoping boom, 31.8' - 101.7', of round hexagonal box construction with three sheaves, 13-1/4" root diameter, at boom head. The synchronization system consists of two telescope cylinders, an extension cable and retraction cable. Hydraulic cylinder fitted with holding valve. Two easily removable wire rope guards, rope dead end provided on both sides of boom head. Boom telescope sections are supported by wear pads both vertically and horizontally. Extension speed 69.9' in 91 seconds.
<b>Boom elevation</b>	By a double acting hydraulic cylinder with holding valve. Elevation 0° - 81°, combination controls for hand or foot operation. Boom angle indicator. Automatic speed reduction and soft stop function. Boom raising speed 20° to 60° in 22 sec.
<b>Jib</b>	Two stage lattice type with 5°, 25° or 45° offset (tilt type). Single sheave, 13-7/8" root diameter, at jib head. Box type top section telescopes from lattice type base section which stores alongside base boom section. Jib length is 23.6' or 42'.
<b>Auxiliary lifting sheave (single top)</b>	Single sheave, 13-1/4" root diameter. Mounted to main boom head for single line work (storable).
<b>Anti-two block</b>	Pendant type over-winding cut out device with audio-visual (FAILURE lamp/BUZZER) warning system.
<b>Slewing</b>	Hydraulic axial piston motor through planetary slewing speed reducer. Continuous 360° full circle slewing on ball bearing turn table at 3.2 min <sup>-1</sup> {rpm}. Equipped with manually locked/released slewing brake. A 360° positive slewing lock for pick and carry and travel modes, manually engaged in cab. Twin slewing system: Free slewing or lock slewing controlled by selector switch on front console.
<b>Hoist</b>	<p><b>MAIN HOIST:</b> Variable speed type with grooved drum driven by hydraulic axial piston motor through speed reducer. Power load lowering and raising. Equipped with automatic brake (neutral brake) and counterbalance valve. Controlled independently of auxiliary hoist. Equipped with cable follower and drum rotation indicator.</p> <p><b>DRUM:</b> Grooved 12-5/8" root diameter x 19-1/16" wide. Wire rope: 558' of 5/8" diameter rope. Drum capacity: 720', 6 layers. Maximum line pull (available): 12,600 lb. Maximum line speed: 436 fpm at the 5th layer.</p> <p><b>AUXILIARY HOIST:</b> Variable speed type with grooved drum driven by hydraulic axial piston motor through speed reducer. Power load lowering and raising. Equipped with automatic brake (neutral brake) and counterbalance valve. Controlled independently of main hoist. Equipped with cable follower and drum rotation indicator.</p> <p><b>DRUM:</b> Grooved 12-5/8" root diameter x 10-3/8" wide. Wire rope: 322' of 5/8" diameter rope. Drum capacity: 392', 6 layers. Maximum line pull (available): 12,600 lb. Maximum line speed: 436 fpm at the 5th layer.</p> <p><b>WIRE ROPE:</b> Filler or Warrington seal wire, extra improved plow steel, preformed, independent wire rope core, right regular lay. Main: 5/8" 6 x 29 class - Auxiliary: 5/8" 6 x 36 class. Breaking strength: Main: 38,800 lb. Auxiliary: 45,900 lb.</p>
<b>Hook blocks</b>	35 ton - 4 sheaves with swivel hook block and safety latch. 4.4 ton - Weighted hook ball with swivel and safety latch.
<b>Hydraulic system</b>	<p><b>PUMPS:</b> Two variable piston pumps for crane functions. Tandem gear pump for steering, slewing and optional equipment. Powered by carrier engine. Pump disconnect for crane is engaged/disengaged by rotary switch from operator's cab.</p> <p><b>CONTROL VALVES:</b> Multiple valves actuated by pilot pressure with integral pressure relief valves.</p> <p><b>RESERVOIR:</b> 100 gallons capacity. External sight level gauge.</p> <p><b>FILTRATION:</b> BETA10 = 10 return filter, full flow with bypass protection, located inside of hydraulic reservoir. Accessible for easy replacement.</p> <p><b>OIL COOLER:</b> Air cooled fan type.</p>
<b>Cab and controls</b>	<p>Both crane and drive operations can be performed from one cab mounted on rotating superstructure. Left side, 1 man type, steel construction with sliding door access and safety glass windows opening at side. Door window is powered control. Windshield glass window and roof glass window are shatter-resistant. Tilt-telescoping steering wheel. Adjustable control lever stands for slewing, boom elevating, boom telescoping, auxiliary hoist and main hoist. Control lever stands can change neutral positions and tilt for easy access to cab. 3 way adjustable operator's seat with high back, headrest and armrest. Engine throttle knob. Foot operated controls: boom elevating, boom telescoping, service brake and engine throttle. Hot water cab heater and air conditioning. Dash-mounted engine start/stop, monitor lamps, cigarette lighter, drive selector switch, parking brake switch, steering mode select switch, power window switch, pump engaged/disengaged switch, slewing brake switch, telescoping/auxiliary hoist select switch, outrigger controls, free slewing / lock slewing selector switch, eco mode switch and ashtray.</p> <p>Instruments: Torque converter oil temperature, engine water temperature, air pressure, fuel, speedometer, tachometer, hour meter and odometer/tripmeter. Hydraulic oil pressure is monitored and displayed on the AML-C display panel.</p>

# Technical Description

## Crane specifications

Tadano electronic LOAD MOMENT INDICATOR system (AML-C) including:  
 Control lever lockout function. Boom position indicator. Outrigger state indicator. Boom angle / boom length / jib offset angle / jib length / load radius / rated lifting capacities / actual loads read out. Ratio of actual load moment to rated load moment indication. Automatic speed reduction and slow stop function on boom elevation and slewing. Working condition register switch. Load radius / boom angle / tip height / slewing range preset function. External warning lamp. Tare function. Fuel consumption monitor. Main hoist / auxiliary hoist select. Drum rotation indicator (audible and visible type) main and auxiliary hoist.

TADANO AML-C monitors outrigger extended length and automatically programs the corresponding "RATED LIFTING CAPACITIES" table.

Operator's right hand console includes transmission gear selector, and slewing lock lever and sight level bubble. Upper console includes working light switch, roof washer and wiper switch, emergency outrigger set up key switch, jib equipped/removed select switch, eco mode switch and air conditioning control switch.

*NOTE:* Each crane motion speed is based on unloaded conditions.

## Carrier specifications

<b>Type</b>	Rear engine, left hand steering, driving axle 2-way selected type by manual switch, 4 x 2 front drive, 4 x 4 front and rear drive.
<b>Frame</b>	High tensile steel, all welded mono-box construction.
<b>Engine</b>	Model: Cummins QSB6.7 [Tier 4] · Type: Direct injection diesel · No. of cylinders: 6 · Combustion: 4 cycle, turbo charged and after cooled · Bore x stroke: 4.212 in. x 4.882 in. · Displacement: 409 cu. in liters · Air inlet heater: 24 volt preheat · Air cleaner: Dry type, replaceable element · Oil filter: Full flow with replaceable element · Fuel filter: Full flow with replaceable element · Fuel tank: 79.2 gallons, right side of carrier · Cooling: Liquid pressurized, recirculating by-pass · Radiator: Fin and tube core, thermostat controlled · Fan: Suction type, 9-blade, 28 in. diameter · Starting: 24 volt · Charging: 24 volt system, negative ground · Battery: 2-120 amp. hour · Compressor, air: 17.0 cfm @ 2,400 rpm · Output, max.: Gross 235 HP (175 kW) @ 2,300 rpm · Torque, max.: 655 ft-lb (888 Nm) @ 1,500 rpm · Capacity: Cooling water 7.4 gallons, lubrication 4.0 gallons, fuel 79.2 gallons, DEF 10.0 gallons.
<b>Transmission</b>	Electronically controlled full automatic transmission. Torque converter driving full powershift with driving axle selector. 6 forward and 2 reverse speeds, constant mesh. 4 speeds - high range - 2 wheel drive; 4 wheel drive. 4 speeds - low range - 4 wheel drive.
<b>Travel speed</b>	31 mph.
<b>Gradeability</b>	78% (at stall), 57% (machine should be operated within the limit of engine design (30°: Cummins B6.7).
<b>Axle</b>	Front: Full floating type, steering and driving axle with planetary reduction. Rear: Full floating type, steering and driving axle with planetary reduction and non-spin rear differential.
<b>Steering</b>	Hydraulic power steering controlled by steering wheel. Three steering modes available: 2 wheel front, 4 wheel coordinated and 4 wheel crab.
<b>Suspension</b>	Front: Semi-elliptic leaf springs with hydraulic lockout device. Rear: Semi-elliptic leaf springs with hydraulic lockout device.
<b>Brake systems</b>	Service: Air over hydraulic disc brakes on all 4 wheels. Parking/Emergency: Spring applied-air released brake acting on input shaft of front axle. Auxiliary: Electro-pneumatic operated exhaust brake.
<b>Tires</b>	20.5-25 (OR).
<b>Outriggers</b>	Four hydraulic, beam and jack outriggers. Vertical jack cylinders equipped with integral holding valve. Each outrigger beam and jack is controlled independently from cab. Beams extend to 20' 8" center-line and retract to within 8' 10-1/2" overall width with floats. Outrigger jack floats are attached thus eliminating the need of manually attaching and detaching them. Controls and sight bubble located in superstructure cab. Four outrigger extension lengths are provided with corresponding "RATED LIFTING CAPACITIES" for crane duty in confined areas. Min. extension: 7' 2-5/8" center to center Mid. extension: 16' 4-7/8" center to center Mid. extension: 19' 4-1/4" center to center Max. extension: 20' 8" center to center Float size (diameter): 1' 3- 3/4"

# Technical Description

## Standard equipment

<b>Four section full power partially synchronized boom</b>	31.8' – 101.7'.
<b>Lattice jib (tilt type)</b>	23.6' or 42' – with 5°, 25° or 45° pinned offsets and self storing pins.
<b>Auxiliary lifting sheave</b>	Single top, stowable.
<b>Variable speed main winch</b>	With grooved drum, cable follower and 558' of 5/8" cable.
<b>Variable speed auxiliary winch</b>	With grooved drum, cable follower and 322' of 5/8" cable.
<b>Drum rotation indicator</b>	Audible, visible and thumper type – main and auxiliary hoist.
<b>Anti-two block device</b>	Overwind cutout.
<b>Boom angle indicator</b>	
<b>Tadano electronic load moment indicator system (AML-C)</b>	
<b>Outrigger extension length detector</b>	
<b>Electronic crane monitoring system</b>	
<b>Tadano twin slewing system and 360° positive slewing lock</b>	
<b>Self centering finger control levers</b>	With pilot control.
<b>Control pedals</b>	For boom elevating and boom telescoping.
<b>3 way adjustable cloth seat</b>	With armrests, high back and seat belt.
<b>Tilt-telescoping steering wheel</b>	
<b>Tinted safety glass and sun visor</b>	
<b>Front windshield wiper and washer</b>	
<b>Roof window wiper and washer</b>	
<b>Power window</b>	Cab door.
<b>Rear view mirrors</b>	Right and left side.
<b>Cigarette lighter and ashtray</b>	
<b>Cab floor mat</b>	
<b>Pump disconnect</b>	In operator's cab.
<b>Hydraulic oil cooler</b>	
<b>Hot water cab heater and air conditioner</b>	
<b>Positive control</b>	
<b>Work lights</b>	
<b>Independently controlled outriggers</b>	
<b>Four outrigger extension positions</b>	

# Technical Description

## Standard equipment

### Self-storing outrigger pads

Engine	Cummins QSB6.7 turbo charged after cooled engine (235 HP) with exhaust brake.
--------	---

### Electronic controlled automatic transmission driven by torque converter

Drive / steer	4 x 4 x 4.
---------------	------------

### Non-spin rear differential

Semi-elliptic leaf springs suspension	With hydraulic lockout device (front and rear).
---------------------------------------	---

Tires	20.5-25 (OR).
-------	---------------

### Disc brakes

### Fenders

### Air dryer

Water separator	With filter (high filtration).
-----------------	--------------------------------

### Engine over-run alarm

### Back-up alarm

Low oil pressure / high water temp. warning device	Visual.
--	---------

### Rear steer centering light

### Air cleaner dust indicator

### Full instrumentation package

### Complete highway light package

### Tool storage compartment

### Tire inflation kit

Electric system	24 volt.
-----------------	----------

Hook block	35 ton - 4 sheaves with swivel and safety latch for 5/8" wire rope.
------------	---

Hook ball	4.4 ton with swivel.
-----------	----------------------

Towing hooks	Front and rear.
--------------	-----------------

### Lifting eyes

Hook block tie down	Front bumper.
---------------------	---------------

### Weighted hook storage compartment

### Halogen head lamp

Telematics	Machine data logging and monitoring system with HELLO-NET via internet.
------------	---

### Fuel consumption monitor

### Eco mode system





tac.sales@tadano.com  
www.tadano.com

**Tadano Ltd.**

Kanda Square 18th Floor, 2-2-1 Kanda-Nishikicho, Chiyoda-ku, Tokyo 101-0054, Japan  
Phone: +81-3-6811-7309 (International Division)

**Tadano America Corporation**

4242 West Greens Road, Houston, TX 77066  
Phone: +1 (281) 869-00300 · Fax: +1 (281) 869-0040



Reaching new heights

